

Fold the card in middle so answer is on the back.

What am I ?

I am used for writing.

I am used for drawing.

You can use a rubber if you make a mistake when using me.

[twinkl.co.uk](https://www.twinkl.co.uk)

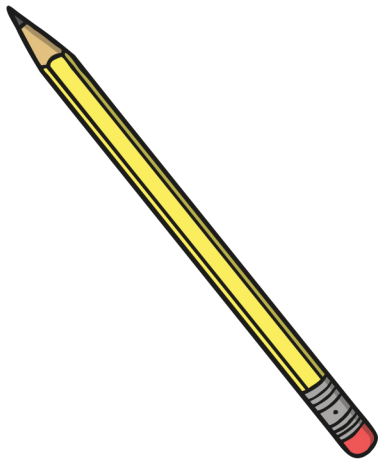

What am I ?

I am light and thin.

I can be used to make things.

I can be used for writing on.

[twinkl.co.uk](https://www.twinkl.co.uk)

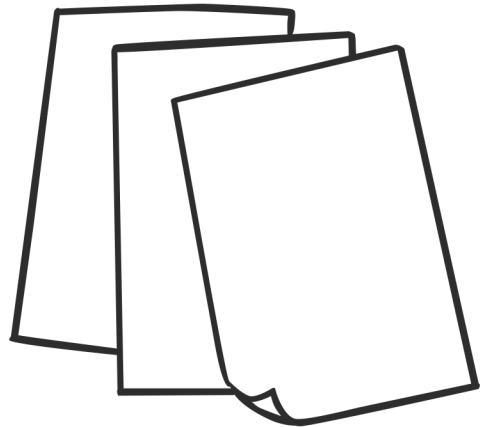

What am I ?

I come in different colours.

I am used for colouring in and drawing.

If the end gets blunt, you can sharpen me.

[twinkl.co.uk](https://www.twinkl.co.uk)

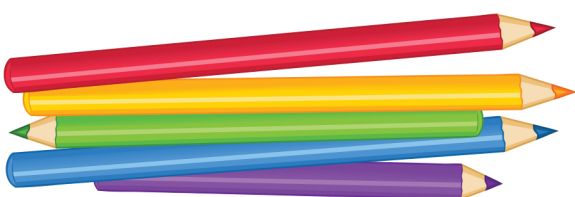

What am I ?

I usually have 4 legs.

I am in your classroom.

You sit at me to do your school work.

[twinkl.co.uk](https://www.twinkl.co.uk)



Fold the card in middle so answer is on the back.

What am I ?

I usually have 4 legs.

I am in your classroom.

You sit on me.

[twinkl.co.uk](https://www.twinkl.co.uk)

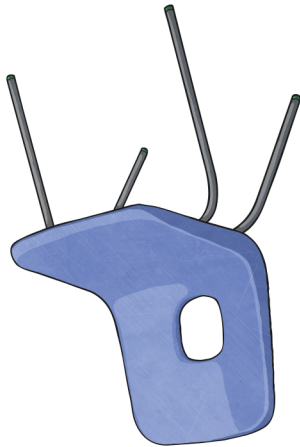

What am I ?

I come in different colours.

I am used for colouring in
and drawing.

I might stain your fingers.

I need a lid.

[twinkl.co.uk](https://www.twinkl.co.uk)

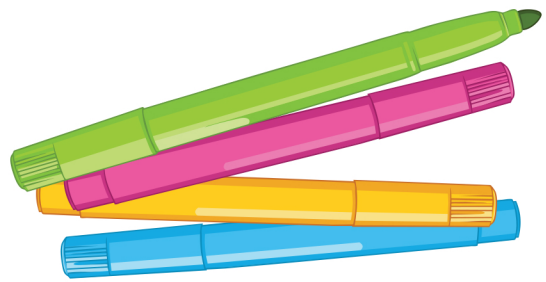

What am I ?

I am used at school.

I am used for measuring things.

I am used for drawing
straight lines.

[twinkl.co.uk](https://www.twinkl.co.uk)



What am I ?

I am used for writing.

I sometimes leak.

If you make a mistake when using
me, you have to cross it out.

[twinkl.co.uk](https://www.twinkl.co.uk)

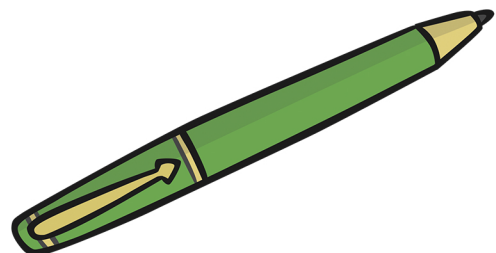

Fold the card in middle so answer is on the back.

What am I ?

I come in different colours
and sizes.

I go to school with you every day.

You put your school books
inside me.

twinkl.co.uk

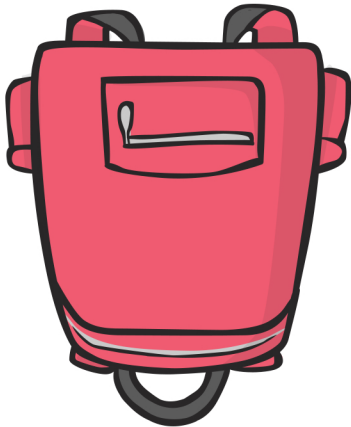

What am I ?

I come in different colours.

I go to school with you every day.

You put your lunch inside me.

twinkl.co.uk

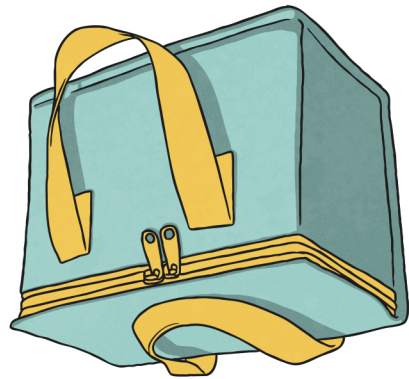

What am I ?

I am in your classroom.

I can help if you make a mistake.

You can use me to rub out
your work.

twinkl.co.uk

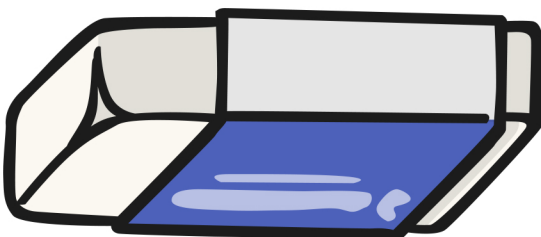

What am I ?

I am in your classroom.

I am used when drawing
or writing.

I am used to make pencils sharp.

twinkl.co.uk

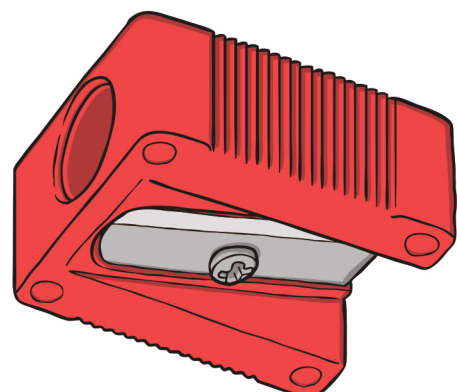

Fold the card in middle so answer is on the back.

What am I ?

I am in your classroom.

I am usually used by the teacher.

I am used to make holes in paper.

[twinkl.co.uk](https://www.twinkl.co.uk)



What am I ?

I am in your classroom.

I am used to stick things together.

I can make your hands sticky.

I need a lid.

[twinkl.co.uk](https://www.twinkl.co.uk)

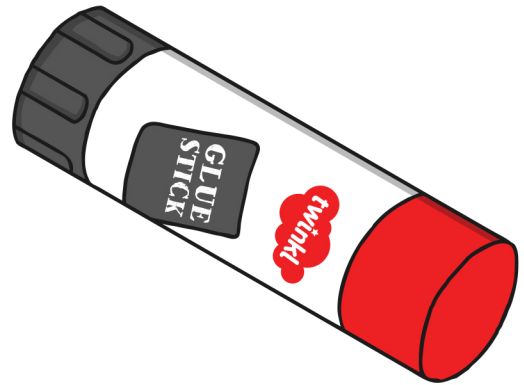

What am I ?

I am in your classroom.

I am used to stick things together.

I am cut into pieces.

It is often tricky to find the end.

[twinkl.co.uk](https://www.twinkl.co.uk)

