

Tiny Talk

A B C

Workbook

www.irLanguage.com

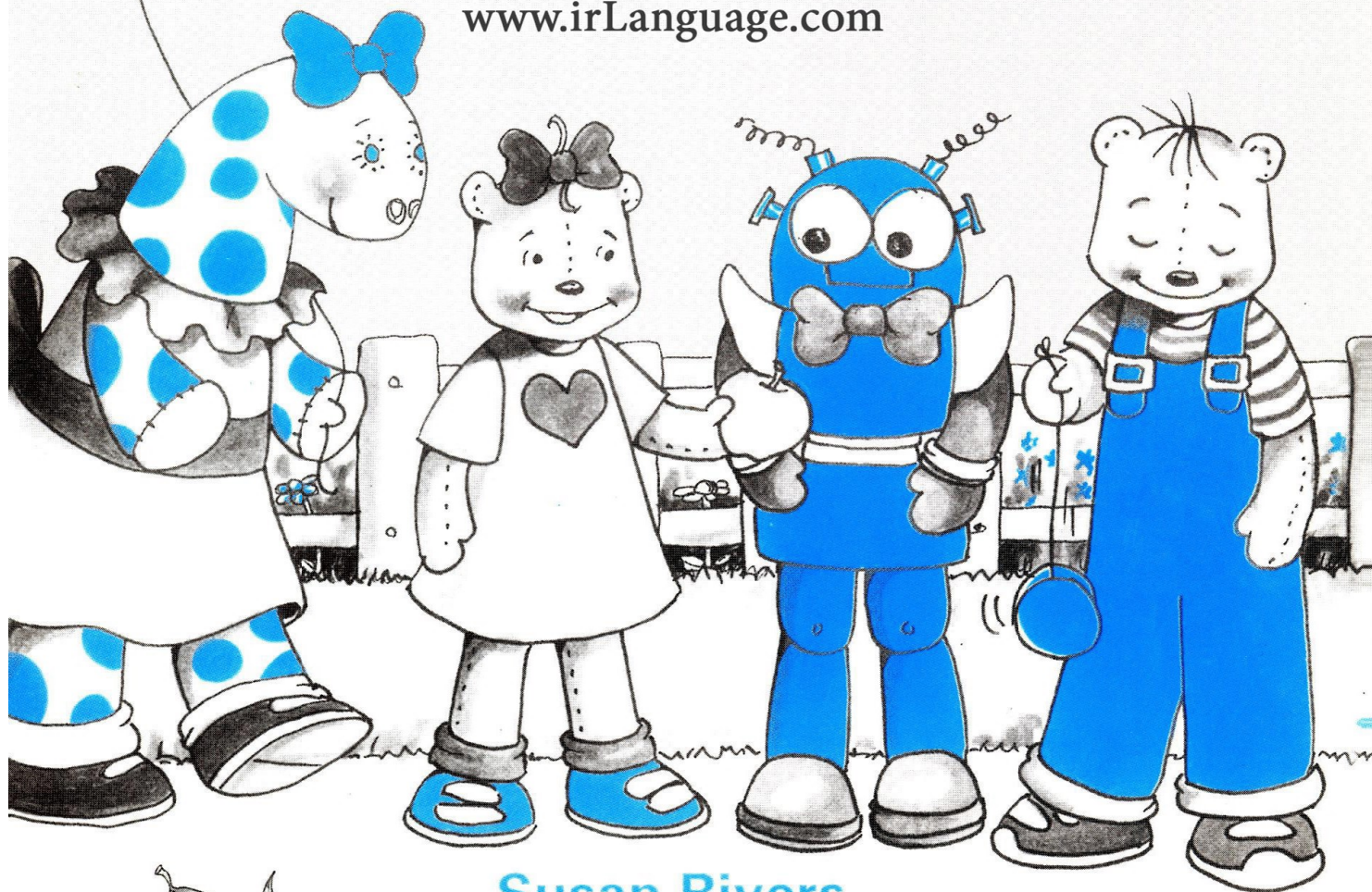

Susan Rivers



Oxford University Press

Tiny Talk

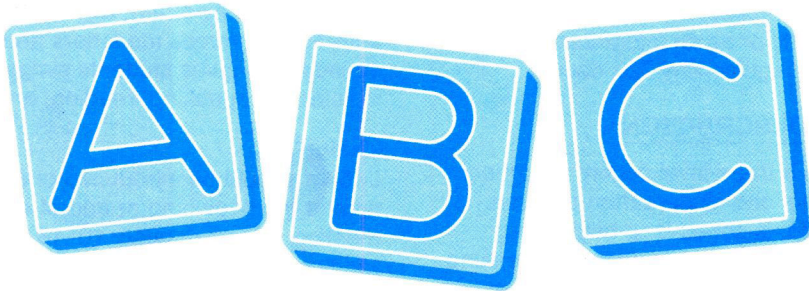

W o r k b o o k

این مجموعه با لوگوی مرجع زبان ایرانیان
به صورت نشر بر خط و حامل به ثبت رسیده است. به ثبت رسیده است.
کپی برداری از آن خلاف شرع، قانون و اخلاق است و شامل پیگیری خواهد شد.

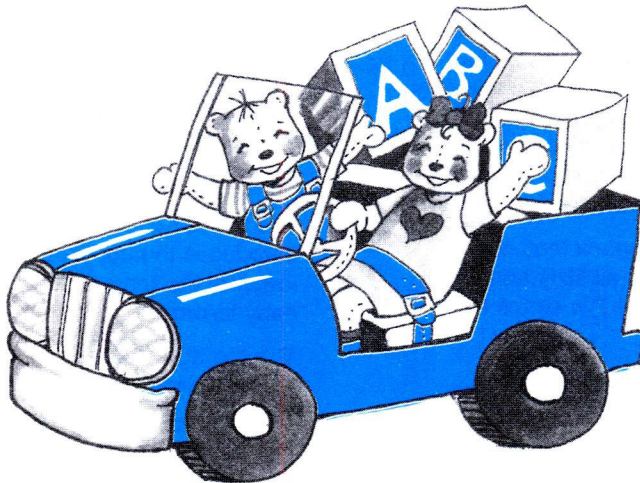

Susan Rivers

Oxford University Press



Introduction

The *Tiny Talk ABC Workbook* introduces preschool students to the letters of the alphabet and their basic sounds. It provides basic listening comprehension activities plus simple practice exercises for reading and writing these letters in a fun and meaningful format.

The *ABC Workbook* can be used either independently or as an integrated supplement to the regular *Tiny Talk* course.

COURSE DESCRIPTION

Tiny Talk is a three-level course designed for preschool and kindergarten children. The goal of this series is to help young children build strong listening and speaking skills in English by having them interact with warm, lovable characters in everyday real-life situations.

The three levels are each divided into A and B sections. Each of these six sections includes a *Student Book*, a *Workbook*, *Picture Cards*, *Wall Charts*, and a *Cassette*. Each *Teacher's Book* combines instructions for both the A and B sections. *Puppets* of the four main characters are also available. By coordinating the use of all these components, the teacher can enable students to understand and practice a wide variety of basic English patterns.

The *Tiny Talk Songbook* features the words and music to all sixty songs written especially for this series by Carolyn Graham.

TINY TALK ABC WORKBOOK

The *Tiny Talk ABC Workbook*, which is used in conjunction with *Tiny Talk Student Book 3A* and *Student Book 3B*, provides young learners with a simple introduction to the alphabet and basic phonics.

It introduces new vocabulary using all twenty-six letters and their sounds, and recycles many words already learned in the regular *Tiny Talk Student Books*.

Very young students will enjoy learning the alphabet through words and pictures that are pertinent and interesting to their age group. A variety of fun, age-appropriate activities reinforces the letters and their sounds, and gives students simple practice in listening, speaking, reading, and writing.

Timing

Letters should be introduced one or two at a time at the beginning or end of each class meeting. Approximately 10–15 minutes are required to teach each letter thoroughly.

TOUR OF A UNIT

The *Tiny Talk ABC Workbook* consists of twenty-six regular units plus two review units (one halfway through the book and one at the end). Each regular unit presents a single letter of the alphabet in a two-page spread.

Every regular unit follows the same lesson progression in five stages. Each stage is clearly cued by simple icons for both teacher and student reference.

1 Letter and Sound Introduction

The top left corner of the left-hand page introduces the upper- and lowercase forms of the target letter in a large, easy-to-recognize format.

The top right corner contains an amusing scene depicting one of the principal *Tiny Talk* characters — the toy bears Benny and Sue — having fun while interacting with two other characters or items that model the target letter. For example, in the second unit (**B b**) Sue is shown about to hand a balloon to a smiling baby.

The two model items are then isolated and enlarged in the middle section of the page for additional sight and sound recognition. Many of these words will be recycled in subsequent phonics activities.

The corresponding section on the *ABC Workbook Cassette* provides additional support for introducing and reviewing the names and sounds of both the target letters and the model words using these letters.

2 Letter Formation Practice

The bottom third of the page provides a simple tracing and writing activity. It not only shows the correct stroke order for writing both the upper- and lowercase forms of the target letter, but also provides clear tracing “templates” over which students can begin to form the letters before proceeding to write them completely on their own.

3 Letter-Reinforcement Activity

The top half of the right-hand page features a letter-reinforcement activity that varies in format from unit to unit.

For example, in one unit students might find and circle letters hidden in a scene; in another they might navigate a simple maze to reach an item that contains the target letter for that unit.

Other activities include coloring vocabulary items that feature target letters, matching pictures to corresponding letters, or finding and circling target letters within a jumble of other letters.

4 Phonics Practice

A phonics activity appearing just below the middle of the page maintains the same format throughout the book.

The teacher either plays the three words for this section on the *ABC Workbook Cassette* or reads them aloud from the tapescript on pages 4–7. Students listen to each of the three words twice, then circle those pictures that feature the target letter for that unit.

For example, in the phonics exercise for the third unit (**C c**) students will see and hear the following three items: *girl, cookie, cat*. They must circle the pictures of the cookie and the cat in their books, but not that of the girl.

5 Chant

The unit concludes with a fun and interactive chant that appears in rebus form at the bottom of the page. The chant provides cumulative review and reinforcement for all the letters learned by students to date.

The teacher can either play the *ABC Workbook Cassette* to lead the chant, or direct the chant personally by referring to the tapescript on pages 4–7.

ABC WORKBOOK CASSETTE

The *ABC Workbook Cassette* features the letter names, their basic sounds, and the simple words used to present these sounds. It also includes the phonics and chant activities for each unit.

Available in either American or British English versions, the *Cassette* clearly and directly models native-speaker pronunciation and intonation. It may be used both in class and at home for extra reinforcement.



Please note the following conventions in the text below:

- (1) Letter names are written in capital letters (for example, E).
- (2) Letter sounds are indicated by phonetic symbols; for example, /k/ represents the "hard C" sound. The phonetic symbols are for adult reference only and should not be taught to young children at the preschool/kindergarten level.
- (3) The five vowels are introduced and modeled only with short vowel sounds.
- (4) Hand claps are indicated by asterisks (*) in the chant lines that appear at the end of each regular unit.

Aa - Pages 8-9

1. Listen and repeat.

A [twice]
 apple [twice]
 ant [twice]
 A, /æ/, apple [twice]
 A, /æ/, ant [twice]

4. Listen and circle.

apple, ant, book [twice each]

5. Chant. Listen and repeat.

A * /æ/ * /æ/ /æ/ /æ/ * [three times]
 [then chant:] A!

4. Listen and circle.

girl, cookie, cat [twice each]

5. Chant. Listen and repeat.

C * /k/ * /k/ /k/ /k/ * [three times]
 [then chant:] A→C!

Dd - Pages 14-15

1. Listen and repeat.

D [twice]
 dinosaur [twice]
 donut [twice]
 D, /d/, dinosaur [twice]
 D, /d/, donut [twice]

4. Listen and circle.

balloon, dog, donut [twice each]

5. Chant. Listen and repeat.

D * /d/ * /d/ /d/ /d/ * [three times]
 [then chant:] A→D!

Bb - Pages 10-11

1. Listen and repeat.

B [twice]
 baby [twice]
 balloon [twice]
 B, /b/, baby [twice]
 B, /b/, balloon [twice]

4. Listen and circle.

baby, door, bear [twice each]

5. Chant. Listen and repeat.

B * /b/ * /b/ /b/ /b/ * [three times]
 [then chant:] A→B!

Ee - Pages 16-17

1. Listen and repeat.

E [twice]
 egg [twice]
 elephant [twice]
 E, /e/, egg [twice]
 E, /e/, elephant [twice]

4. Listen and circle.

elephant, envelope, apple [twice each]

5. Chant. Listen and repeat.

E * /e/ * /e/ /e/ /e/ * [three times]
 [then chant:] A→E!

Cc - Pages 12-13

1. Listen and repeat.

C [twice]
 cat [twice]
 computer [twice]
 C, /k/, cat [twice]
 C, /k/, computer [twice]

Ff – Pages 18–19

1. Listen and repeat.

<i>F</i>	[twice]
<i>fence</i>	[twice]
<i>farmer</i>	[twice]
<i>F, /f/, fence</i>	[twice]
<i>F, /f/, farmer</i>	[twice]

4. Listen and circle.

<i>fish, house, fence</i>	[twice each]
---------------------------	--------------

5. Chant. Listen and repeat.

<i>F * /f/ * /f/ /f/ /f/ *</i>	[three times]
[then chant:] <i>A→F!</i>	

Gg – Pages 20–21

1. Listen and repeat.

<i>G</i>	[twice]
<i>gorilla</i>	[twice]
<i>garden</i>	[twice]
<i>G, /g/, gorilla</i>	[twice]
<i>G, /g/, garden</i>	[twice]

4. Listen and circle.

<i>key, garden, goat</i>	[twice each]
--------------------------	--------------

5. Chant. Listen and repeat.

<i>G * /g/ * /g/ /g/ /g/ *</i>	[three times]
[then chant:] <i>A→G!</i>	

Hh – Pages 22–23

1. Listen and repeat.

<i>H</i>	[twice]
<i>house</i>	[twice]
<i>helicopter</i>	[twice]
<i>H, /h/, house</i>	[twice]
<i>H, /h/, helicopter</i>	[twice]

4. Listen and circle.

<i>hot dog, house, farmer</i>	[twice each]
-------------------------------	--------------

5. Chant. Listen and repeat.

<i>H * /h/ * /h/ /h/ /h/ *</i>	[three times]
[then chant:] <i>A→H!</i>	

Ii – Pages 24–25

1. Listen and repeat.

<i>I</i>	[twice]
<i>igloo</i>	[twice]
<i>insect</i>	[twice]
<i>I, /i/, igloo</i>	[twice]
<i>I, /i/, insect</i>	[twice]

4. Listen and circle.

<i>alligator, insect, igloo</i>	[twice each]
---------------------------------	--------------

5. Chant. Listen and repeat.

<i>I * /i/ * /i/ /i/ /i/ *</i>	[three times]
[then chant:] <i>A→I!</i>	

Jj – Pages 26–27

1. Listen and repeat.

<i>J</i>	[twice]
<i>jeep</i>	[twice]
<i>juice</i>	[twice]
<i>J, /dʒ/, jeep</i>	[twice]
<i>J, /dʒ/, juice</i>	[twice]

4. Listen and circle.

<i>juice, king, jacket</i>	[twice each]
----------------------------	--------------

5. Chant. Listen and repeat.

<i>J * /dʒ/ * /dʒ/ /dʒ/ /dʒ/ *</i>	[three times]
[then chant:] <i>A→J!</i>	

Kk – Pages 28–29

1. Listen and repeat.

<i>K</i>	[twice]
<i>kite</i>	[twice]
<i>kangaroo</i>	[twice]
<i>K, /k/, kite</i>	[twice]
<i>K, /k/, kangaroo</i>	[twice]

4. Listen and circle.

<i>kite, girl, key</i>	[twice each]
------------------------	--------------

5. Chant. Listen and repeat.

<i>K * /k/ * /k/ /k/ /k/ *</i>	[three times]
[then chant:] <i>A→K!</i>	

Ll – Pages 30–31

1. Listen and repeat.

<i>L</i>	[twice]
<i>leaf</i>	[twice]
<i>lamb</i>	[twice]
<i>L, /l/, leaf</i>	[twice]
<i>L, /l/, lamb</i>	[twice]

4. Listen and circle.

<i>leaf, hand, lollipop</i>	[twice each]
-----------------------------	--------------

5. Chant. Listen and repeat.

<i>L * /l/ * /l/ /l/ /l/ *</i>	[three times]
[then chant:] <i>A→L!</i>	



Mm – Pages 32–33

1. Listen and repeat.

<i>M</i>	[twice]
<i>mirror</i>	[twice]
<i>monster</i>	[twice]
<i>M, /m/, mirror</i>	[twice]
<i>M, /m/, monster</i>	[twice]

4. Listen and circle.

mirror, moon, ladder [twice each]

5. Chant. Listen and repeat.

*M * /m/ * /m/ /m/ /m/ ** [three times]
[then chant:] *A→M!*

Nn – Pages 36–37

1. Listen and repeat.

<i>N</i>	[twice]
<i>nest</i>	[twice]
<i>newspaper</i>	[twice]
<i>N, /n/, nest</i>	[twice]
<i>N, /n/, newspaper</i>	[twice]

4. Listen and circle.

nest, monkey, nurse [twice each]

5. Chant. Listen and repeat.

*N * /n/ * /n/ /n/ /n/ ** [three times]
[then chant:] *A→N!*

Oo – Pages 38–39

1. Listen and repeat.

<i>O</i>	[twice]
<i>octopus</i>	[twice]
<i>ox</i>	[twice]
<i>O, /a/, octopus</i>	[twice]
<i>O, /a/, ox</i>	[twice]

4. Listen and circle.

octopus, elevator, ostrich [twice each]

5. Chant. Listen and repeat.

*O * /a/ * /a/ /a/ /a/ ** [three times]
[then chant:] *A→O!*

Pp – Pages 40–41

1. Listen and repeat.

<i>P</i>	[twice]
<i>pizza</i>	[twice]
<i>pirate</i>	[twice]
<i>P, /p/, pizza</i>	[twice]
<i>P, /p/, pirate</i>	[twice]

4. Listen and circle.

bird, pizza, piano [twice each]

5. Chant. Listen and repeat.

*P * /p/ * /p/ /p/ /p/ ** [three times]
[then chant:] *A→P!*

Qq – Pages 42–43

1. Listen and repeat.

<i>Q</i>	[twice]
<i>quilt</i>	[twice]
<i>queen</i>	[twice]
<i>Q, /kw/, quilt</i>	[twice]
<i>Q, /kw/, queen</i>	[twice]

4. Listen and circle.

question mark, garden, queen [twice each]

5. Chant. Listen and repeat.

*Q * /kw/ * /kw/ /kw/ /kw/ ** [three times]
[then chant:] *A→Q!*

Rr – Pages 44–45

1. Listen and repeat.

<i>R</i>	[twice]
<i>rocket</i>	[twice]
<i>rainbow</i>	[twice]
<i>R, /r/, rocket</i>	[twice]
<i>R, /r/, rainbow</i>	[twice]

4. Listen and circle.

rainbow, lamp, robot [twice each]

5. Chant. Listen and repeat.

*R * /r/ * /r/ /r/ /r/ ** [three times]
[then chant:] *A→R!*

Ss – Pages 46–47

1. Listen and repeat.

<i>S</i>	[twice]
<i>sun</i>	[twice]
<i>sandbox</i>	[twice]
<i>S, /s/, sun</i>	[twice]
<i>S, /s/, sandbox</i>	[twice]

4. Listen and circle.

sock, sun, fan [twice each]

5. Chant. Listen and repeat.

*S * /s/ * /s/ /s/ /s/ ** [three times]
[then chant:] *A→S!*



Tt – Pages 48–49

1. Listen and repeat.

<i>T</i>	[twice]
<i>turtle</i>	[twice]
<i>telephone</i>	[twice]
<i>T, /t/, turtle</i>	[twice]
<i>T, /t/, telephone</i>	[twice]

4. Listen and circle.

dog, tiger, telephone [twice each]

5. Chant. Listen and repeat.

T /t/ * /t/ /t/ /t/ ** [three times]
[then chant:] *A→T!*

Uu – Pages 50–51

1. Listen and repeat.

<i>U</i>	[twice]
<i>umbrella</i>	[twice]
<i>upstairs</i>	[twice]
<i>U, /ʌ/, umbrella</i>	[twice]
<i>U, /ʌ/, upstairs</i>	[twice]

4. Listen and circle.

umbrella, underwear, ostrich [twice each]

5. Chant. Listen and repeat.

U /ʌ/ * /ʌ/ /ʌ/ /ʌ/ ** [three times]
[then chant:] *A→U!*

Vv – Pages 52–53

1. Listen and repeat.

<i>V</i>	[twice]
<i>van</i>	[twice]
<i>vegetables</i>	[twice]
<i>V, /v/, van</i>	[twice]
<i>V, /v/, vegetables</i>	[twice]

4. Listen and circle.

flower, violin, vegetables [twice each]

5. Chant. Listen and repeat.

V /v/ * /v/ /v/ /v/ ** [three times]
[then chant:] *A→V!*

Ww – Pages 54–55

1. Listen and repeat.

<i>W</i>	[twice]
<i>worm</i>	[twice]
<i>watermelon</i>	[twice]
<i>W, /w/, worm</i>	[twice]
<i>W, /w/, watermelon</i>	[twice]

4. Listen and circle.

worm, hat, witch [twice each]

5. Chant. Listen and repeat.

W /w/ * /w/ /w/ /w/ ** [three times]
[then chant:] *A→W!*

Xx – Pages 56–57

1. Listen and repeat.

<i>X</i>	[twice]
<i>fox</i>	[twice]
<i>six</i>	[twice]
<i>X, /ks/, fox</i>	[twice]
<i>X, /ks/, six</i>	[twice]

4. Listen and circle.

box, six, book [twice each]

5. Chant. Listen and repeat.

X /ks/ * /ks/ /ks/ /ks/ ** [three times]
[then chant:] *A→X!*

Yy – Pages 58–59

1. Listen and repeat.

<i>Y</i>	[twice]
<i>yo-yo</i>	[twice]
<i>yogurt</i>	[twice]
<i>Y, /j/, yo-yo</i>	[twice]
<i>Y, /j/, yogurt</i>	[twice]

4. Listen and circle.

water, yawn, yo-yo [twice each]

5. Chant. Listen and repeat.

Y /j/ * /j/ /j/ /j/ ** [three times]
[then chant:] *A→Y!*

Zz – Pages 60–61

1. Listen and repeat.

<i>Z</i>	[twice]
<i>zebra</i>	[twice]
<i>zoo</i>	[twice]
<i>Z, /z/, zebra</i>	[twice]
<i>Z, /z/, zoo</i>	[twice]

4. Listen and circle.

zoo, spider, zipper [twice each]

5. Chant. Listen and repeat.

Z /z/ * /z/ /z/ /z/ ** [three times]
[then chant:] *A→Z!*





A a

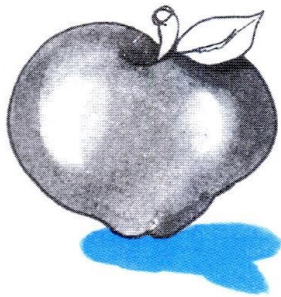

apple

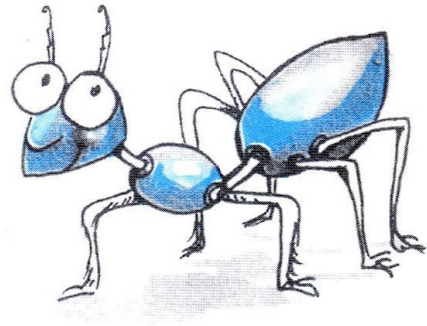

ant

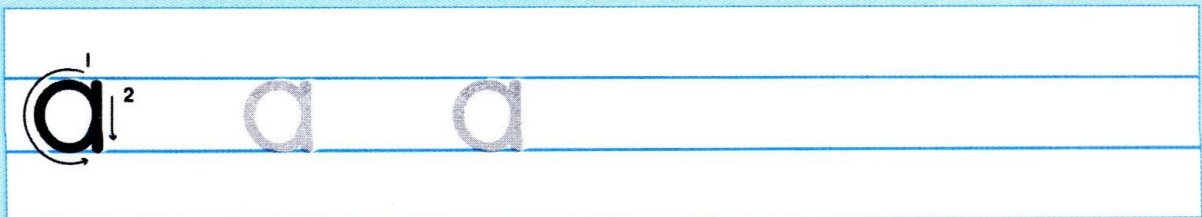
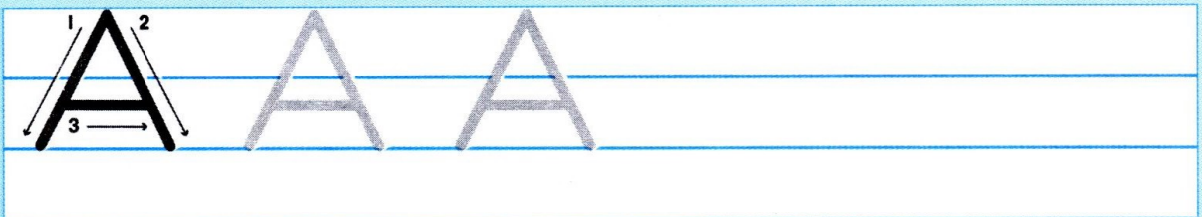

3



Find and circle the "A" and "a" letters.

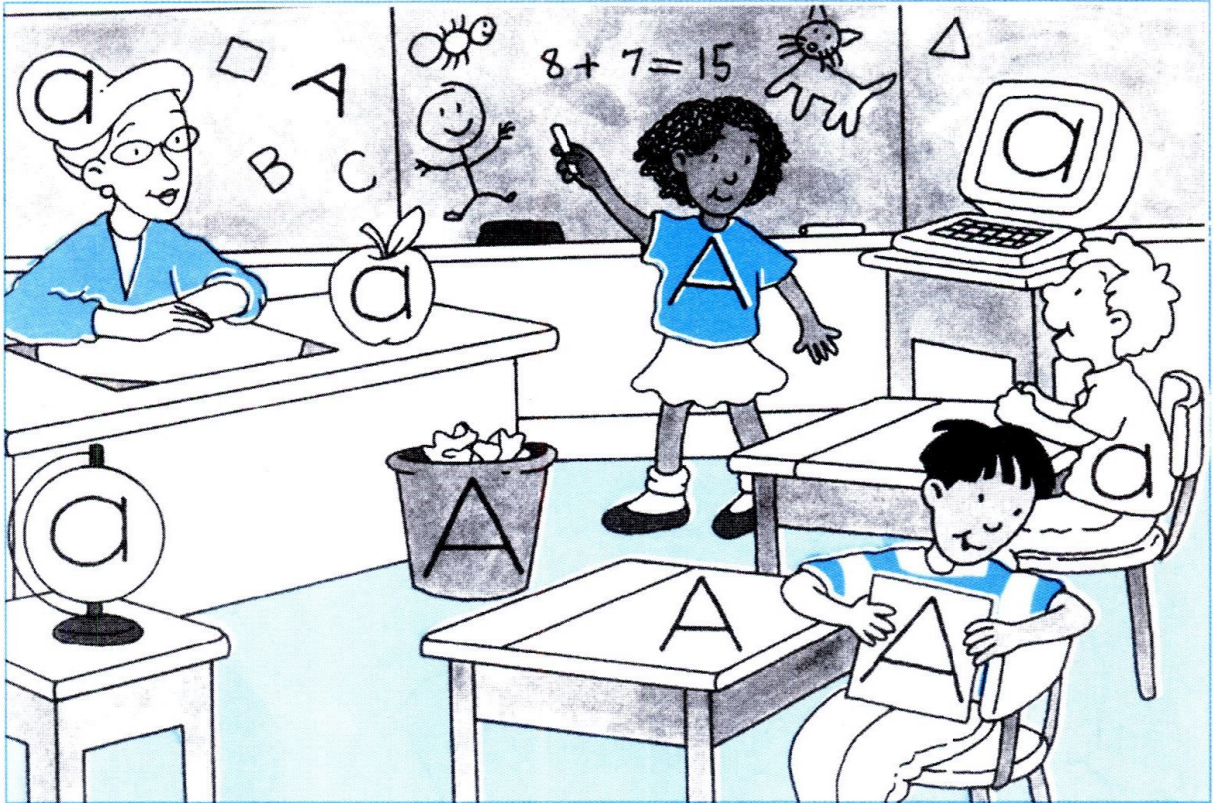

4

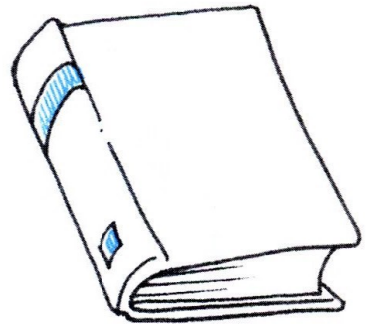
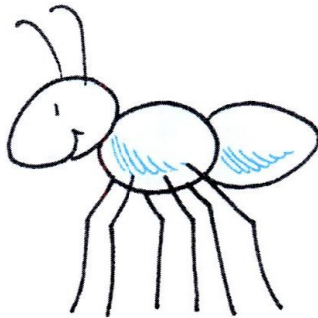

5



A



A



A

A

A





Bb



baby

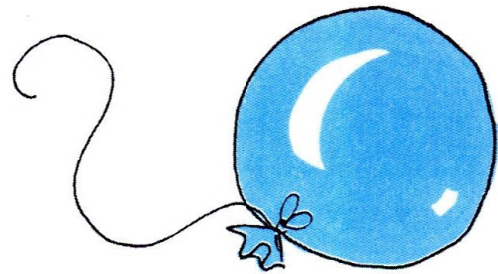

balloon



3



Find the balloon.

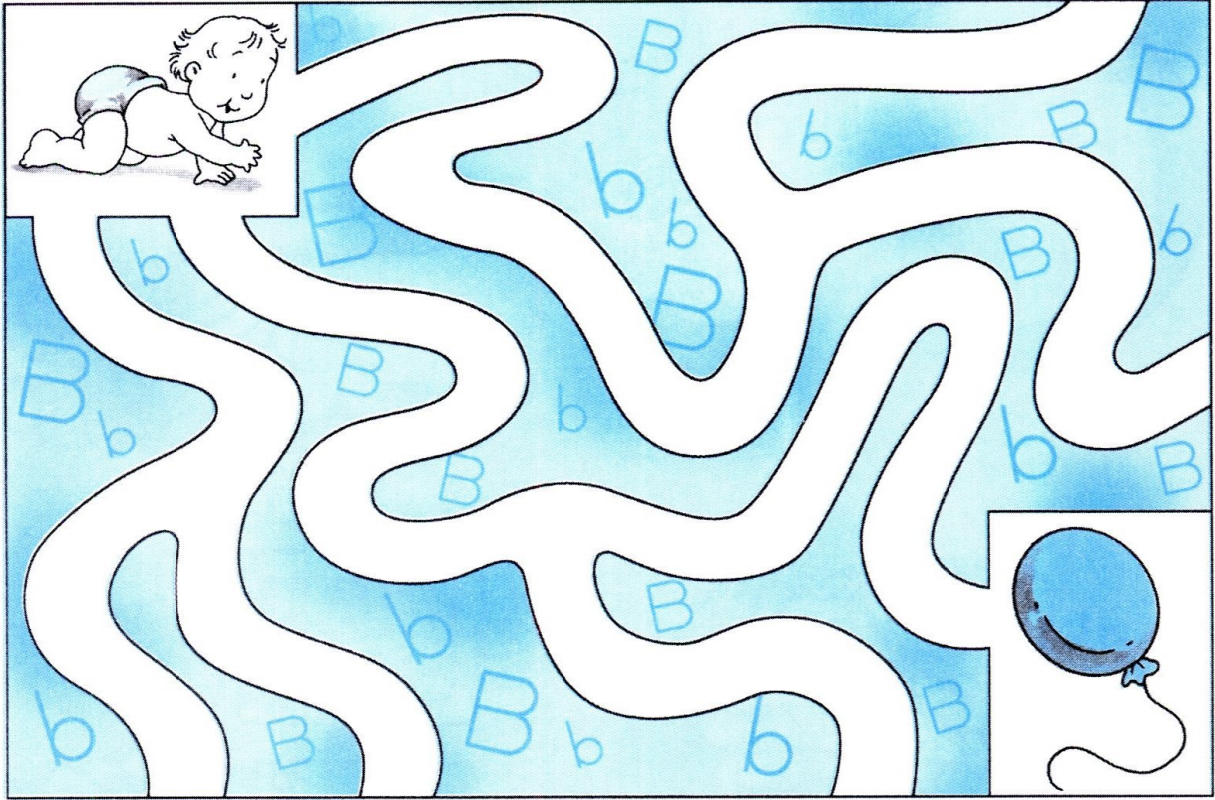

4

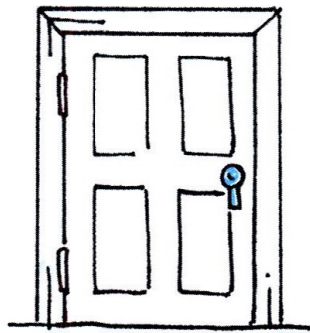

5



B



B



B

B

B



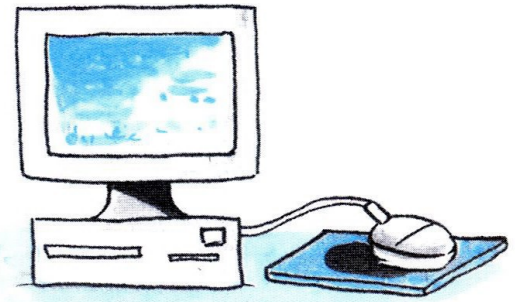
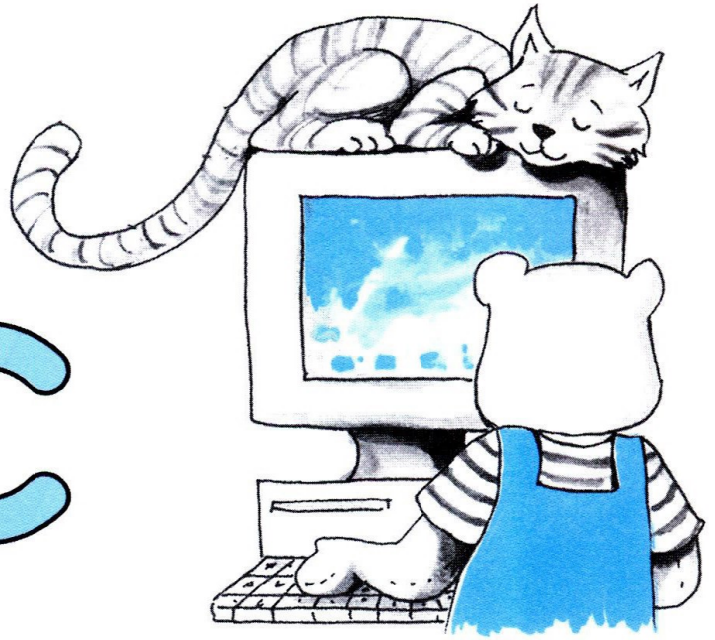
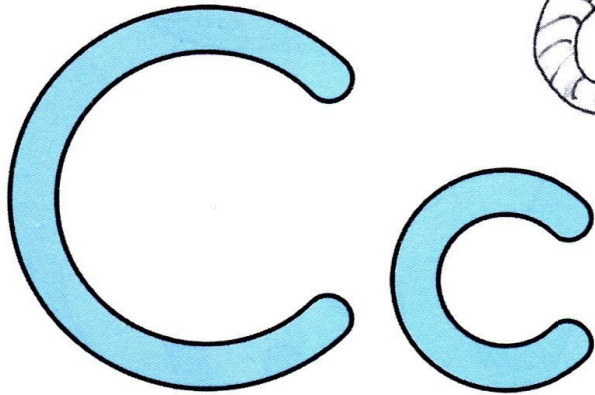

cat

computer

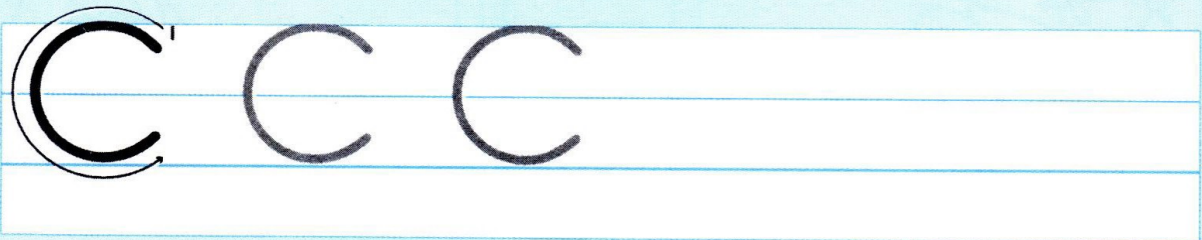

3



Match.

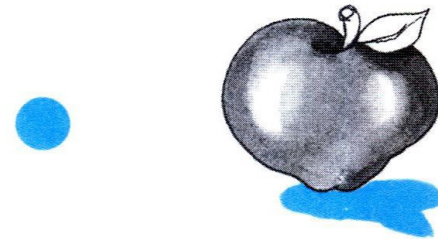
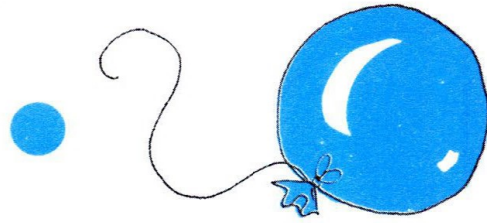
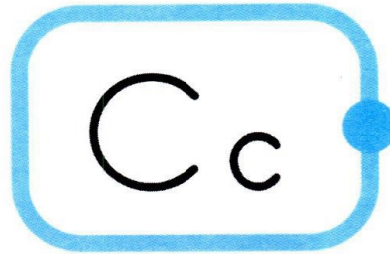
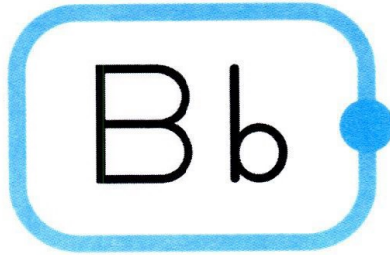
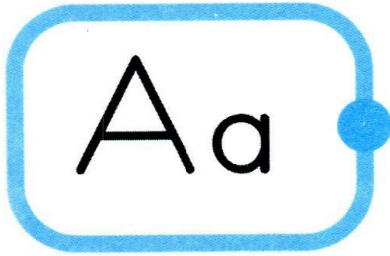

4

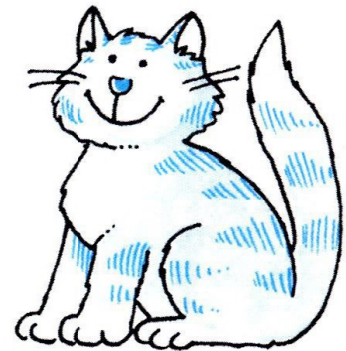
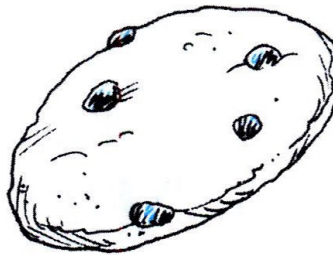

5



C



C



C

C

C





D d

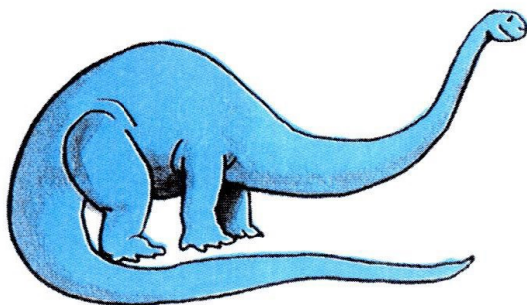
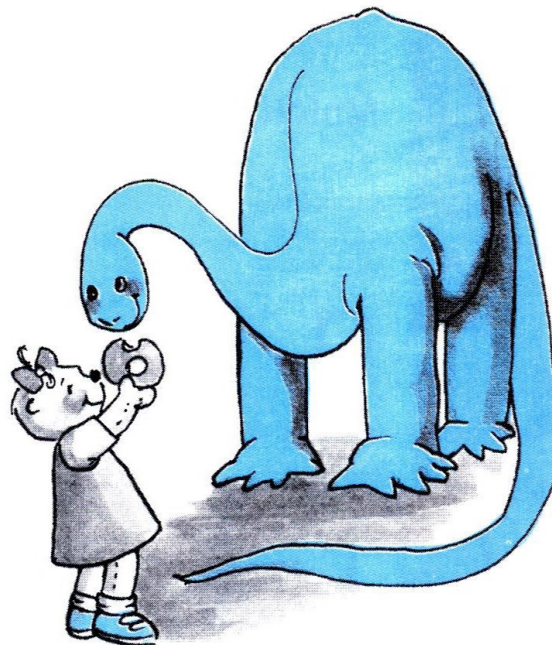

dinosaur

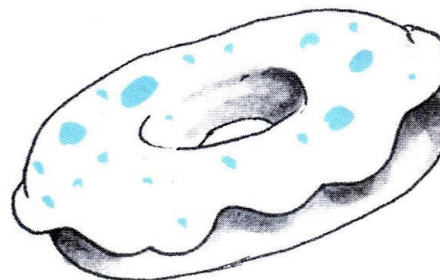

donut

2



www.irLanguage.com

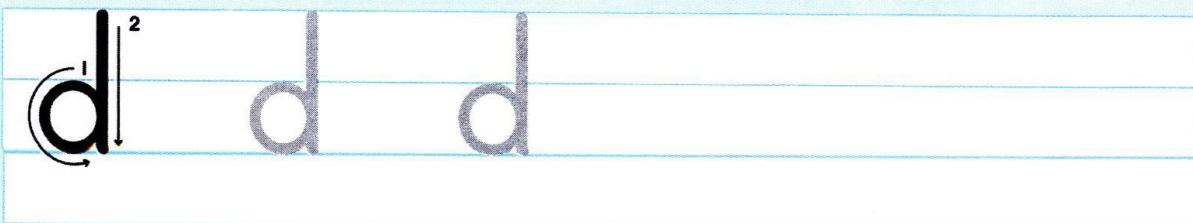
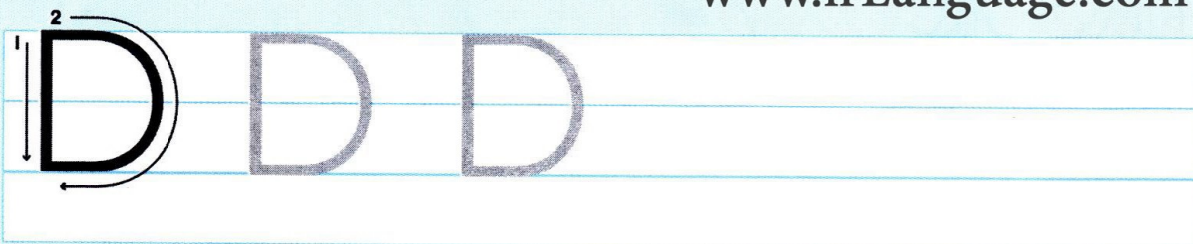

3



Color the "d" words.

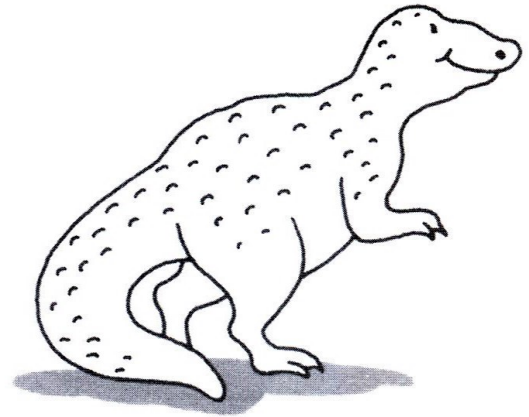
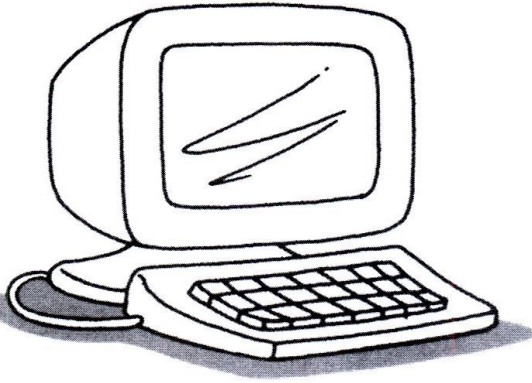
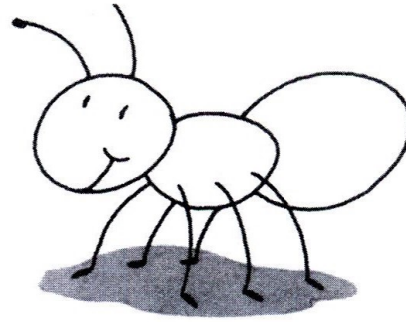
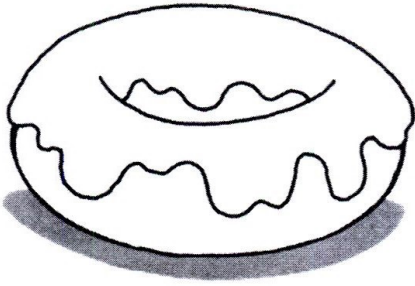

4

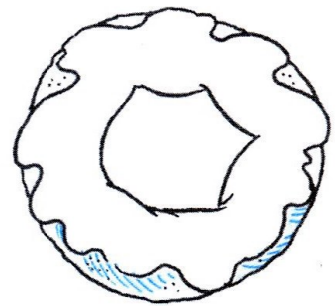
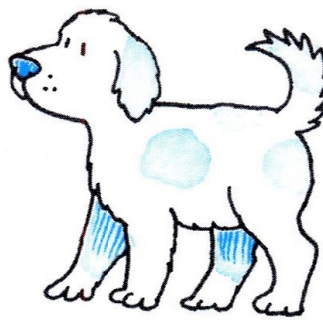
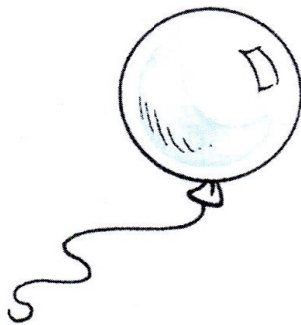

5



D



D



D

D

D





E e

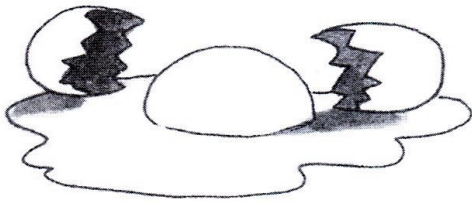

egg

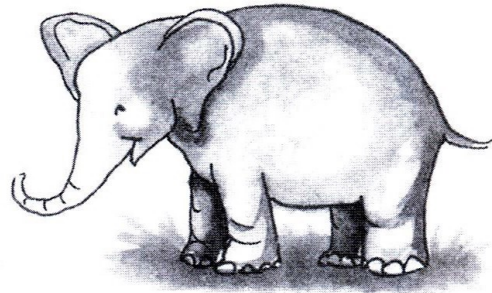

elephant

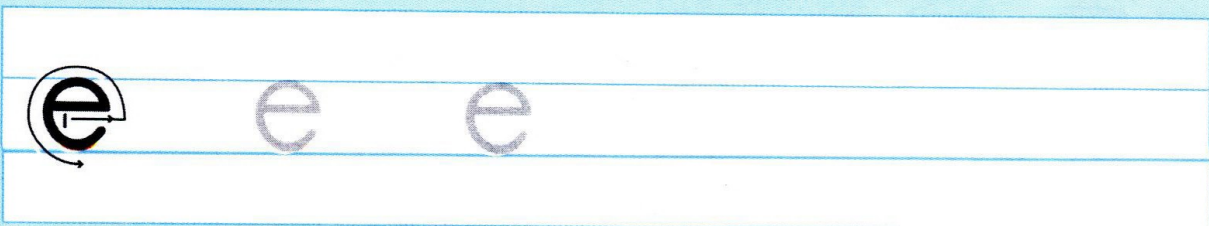
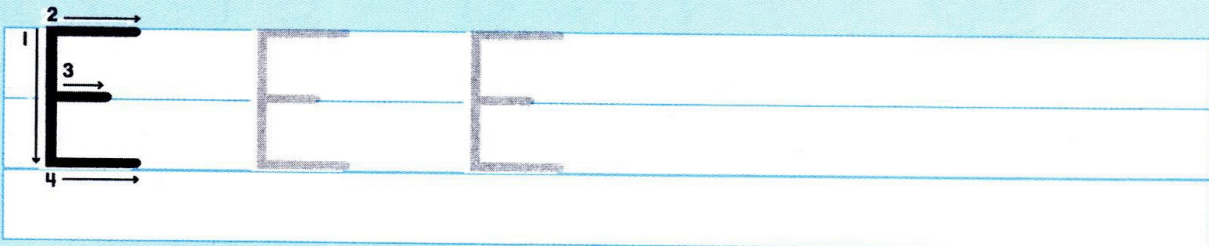

3



Circle the "E" and "e" letters.

E B A E E
C E B D A

e c e d
a b e a

4

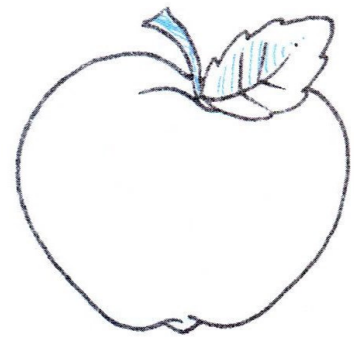
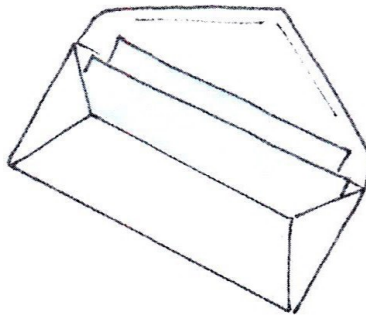
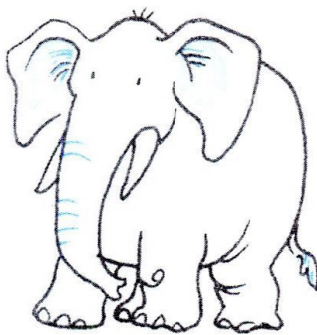

5



E



E



E

E

E



1



F f

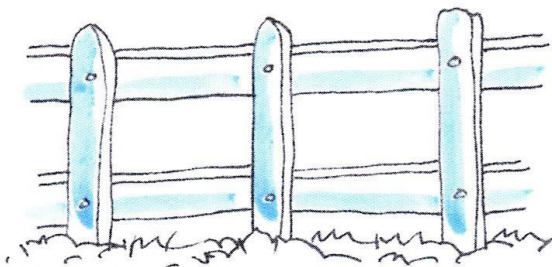

fence



farmer

2



www.irLanguage.com

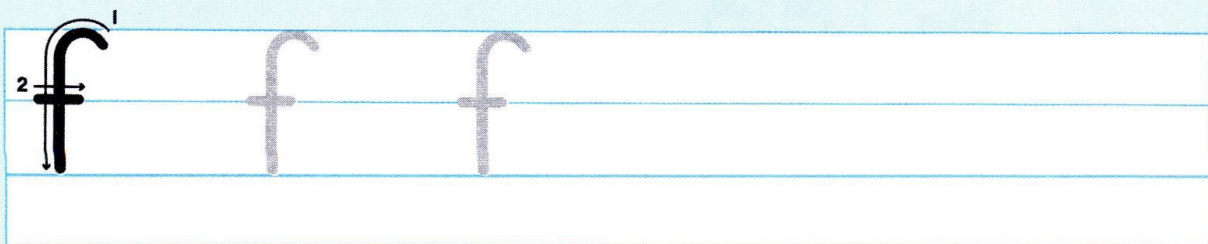
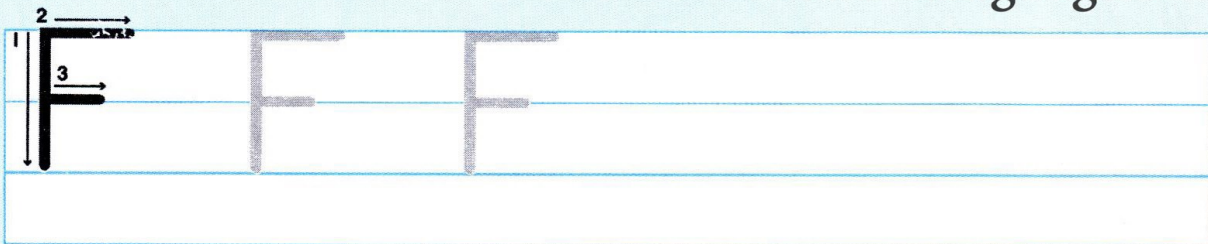

3



Find and circle the letters.

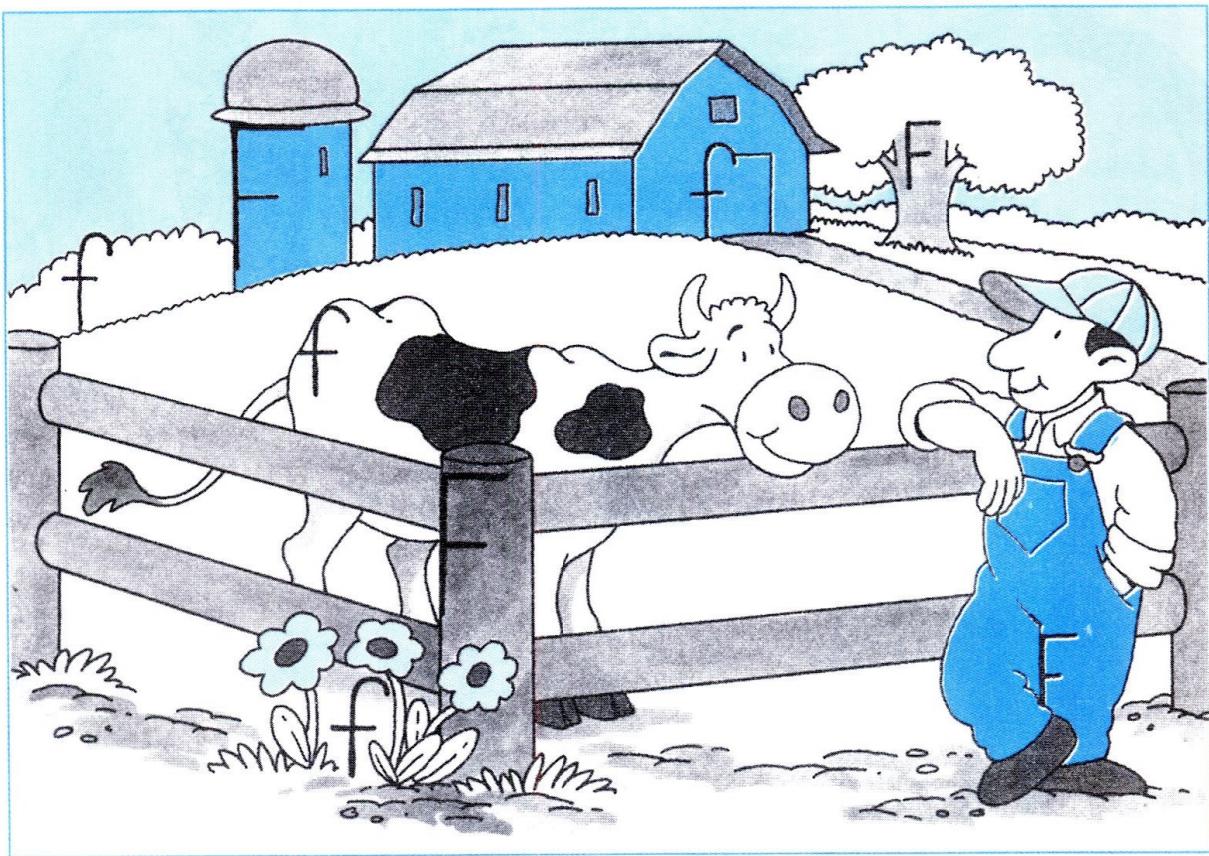

4

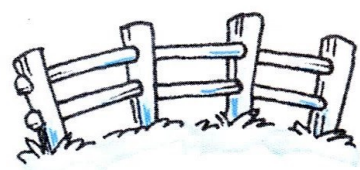

5



F



F



F

F

F



1



Gg



gorilla

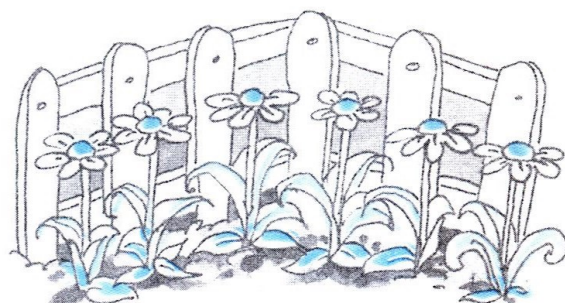

garden

2

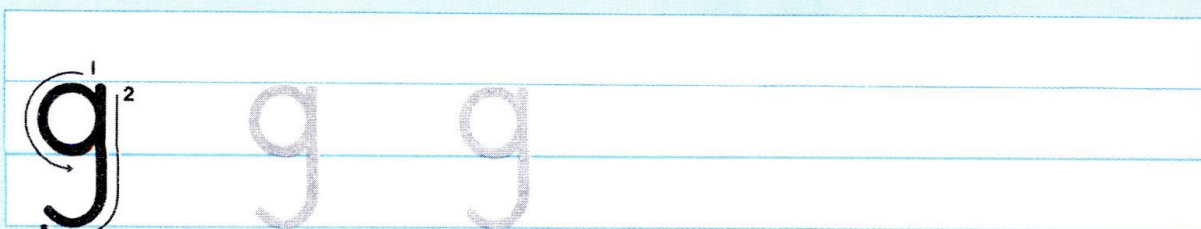

3  Find the garden.

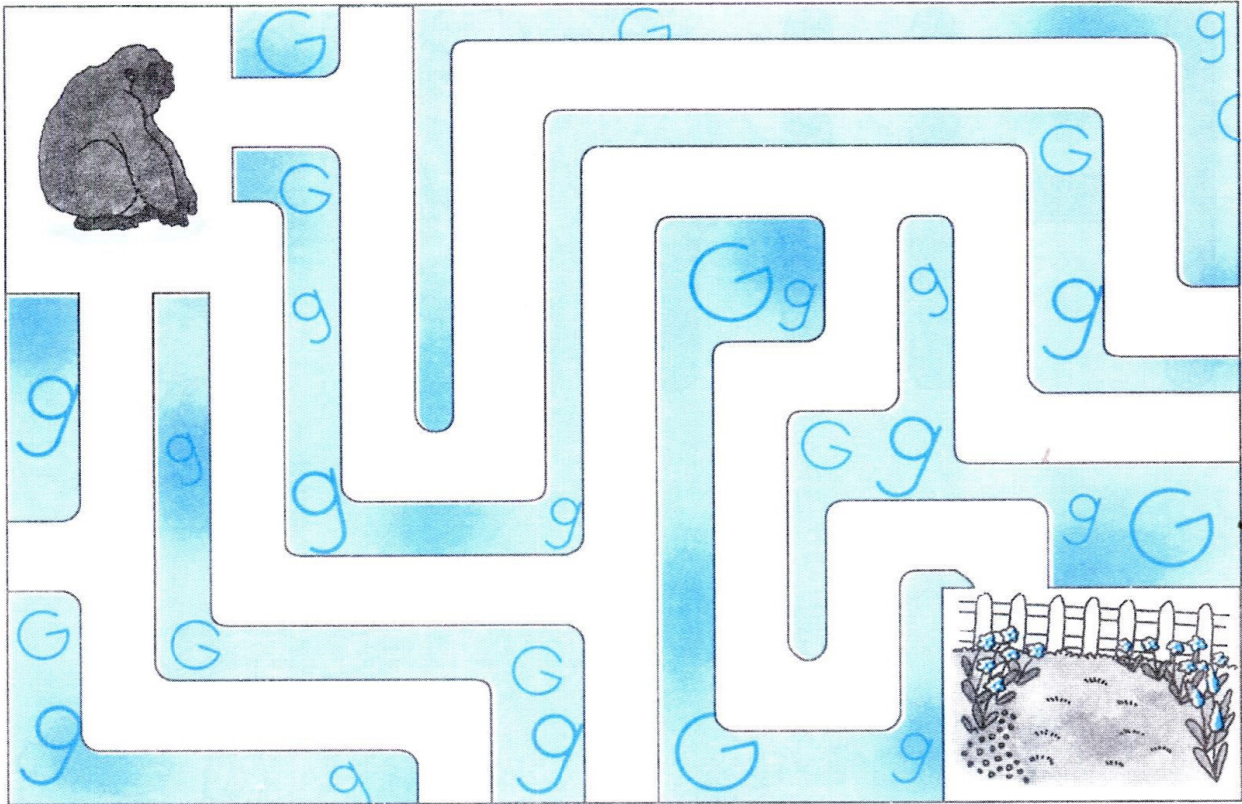

4   

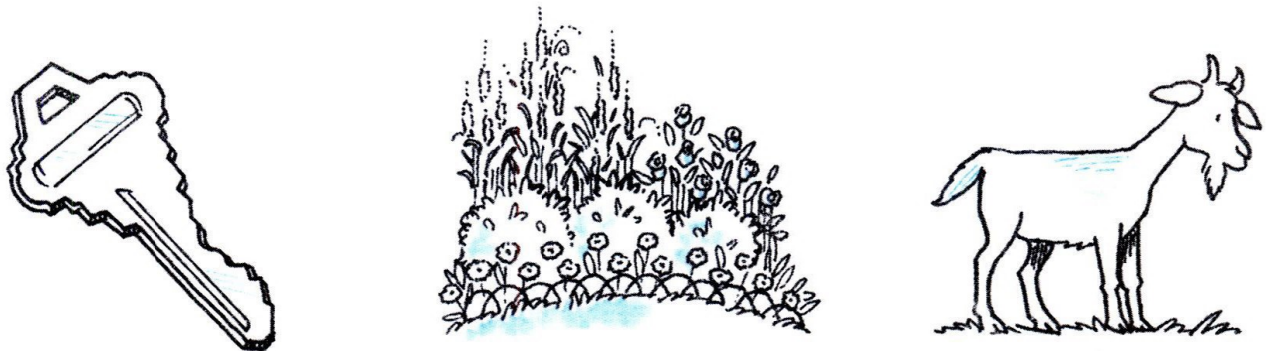

5    



1



H h



house



helicopter

2

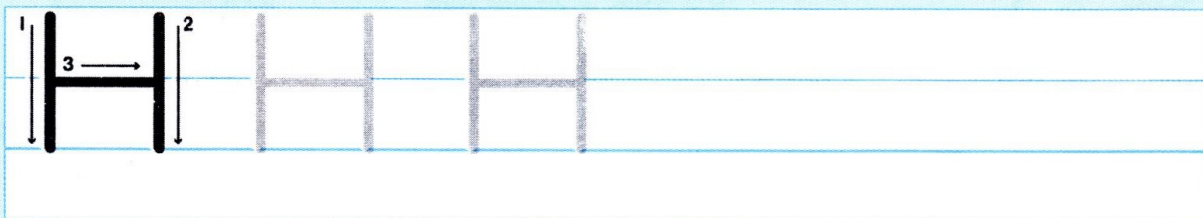
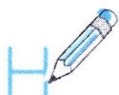

3



Match.

Ff

Gg

Hh

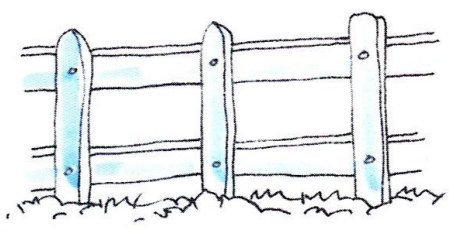
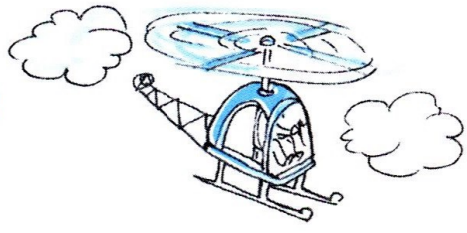

4

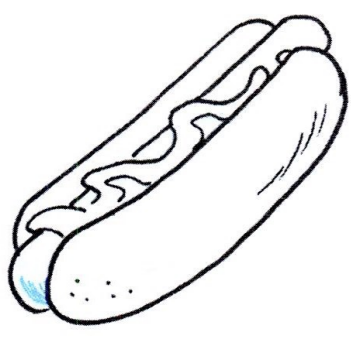

5



H



H



H

H

H



1



I i

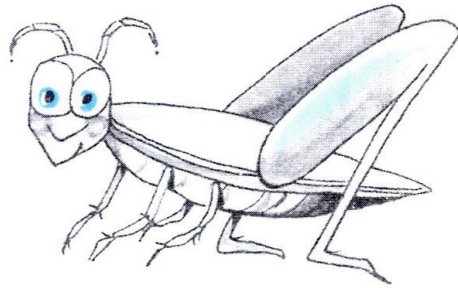
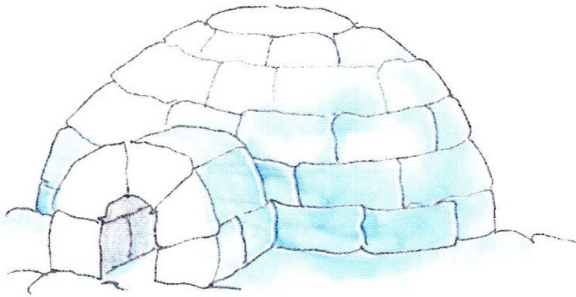
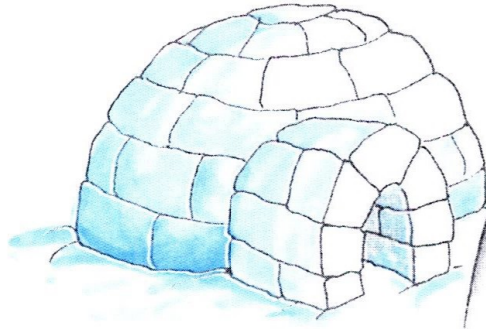

igloo

insect

2

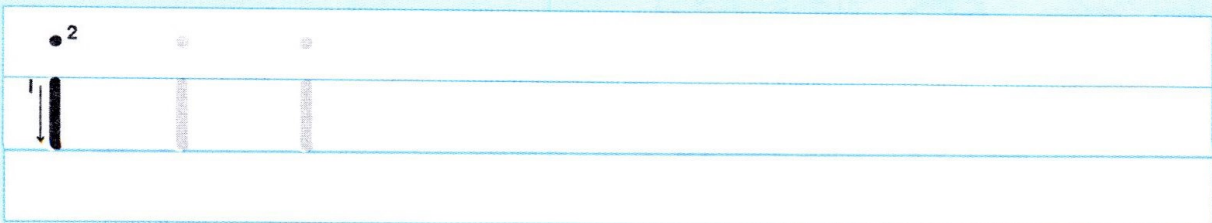
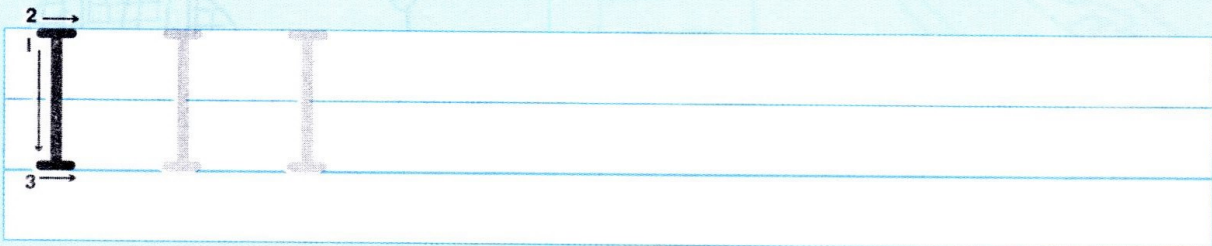

3



Circle the "I" and "i" letters.

I F I A I H
I E D I

i f i i
h i b g d

4

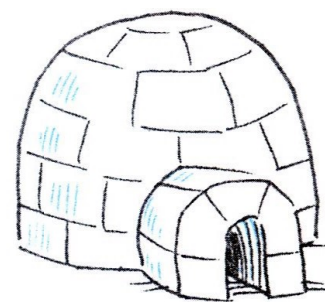
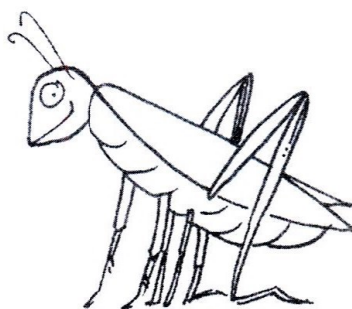
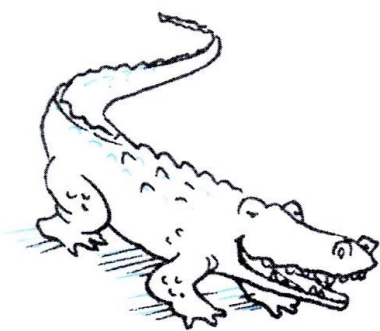

5



I I I I I

1



J j

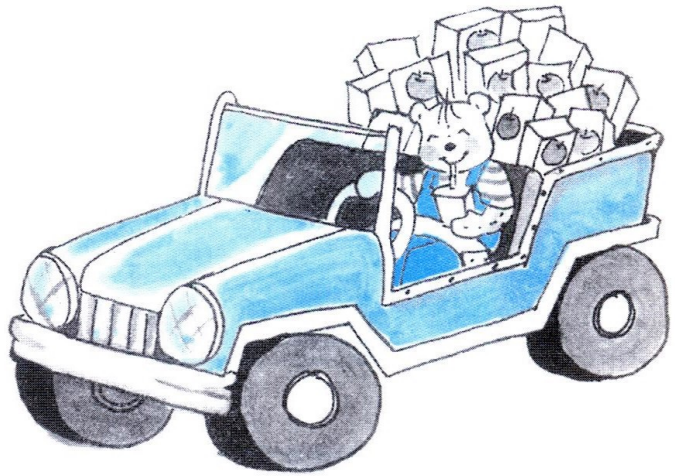

jeep

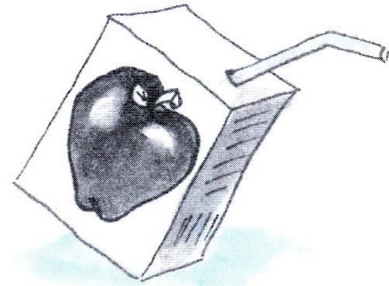

juice

2

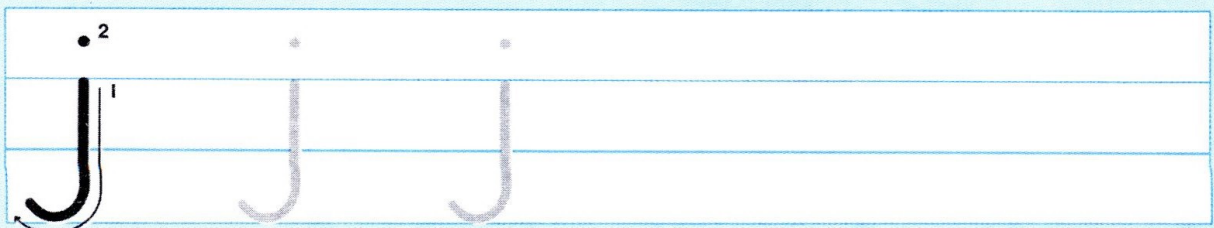
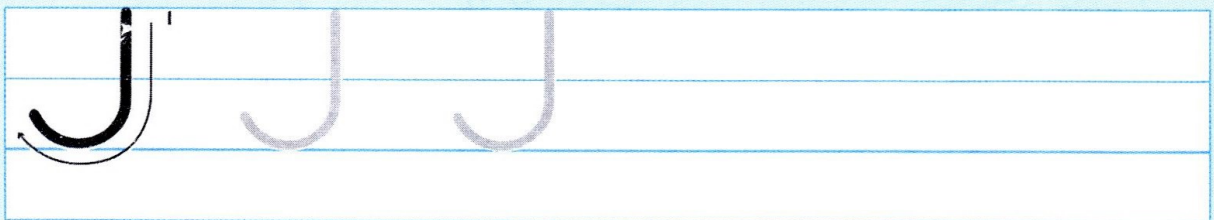

3



Color the "j" words.

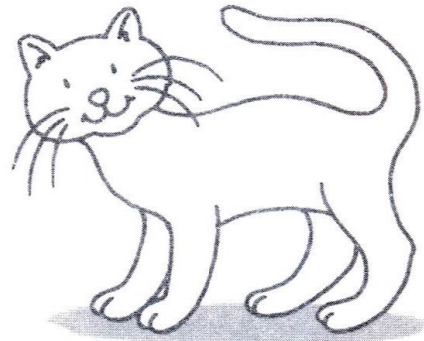
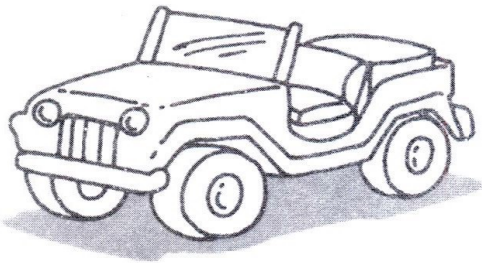
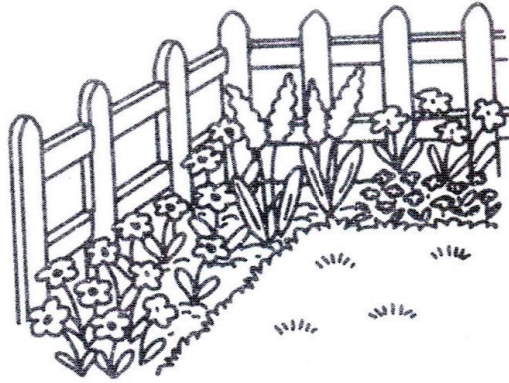
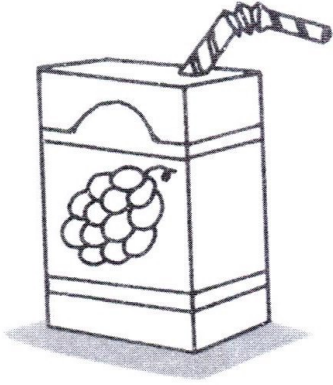

4

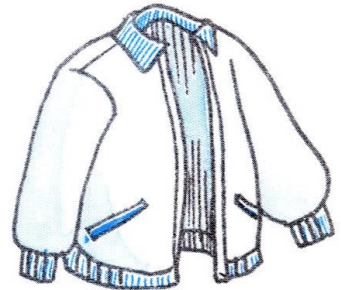
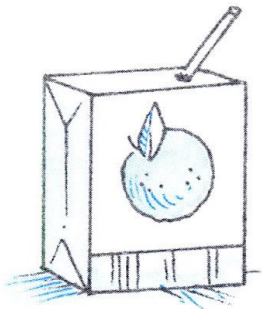

5

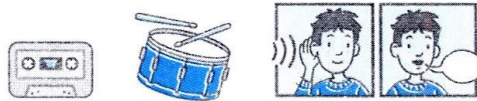

J



J



J

J

J



1



Kk

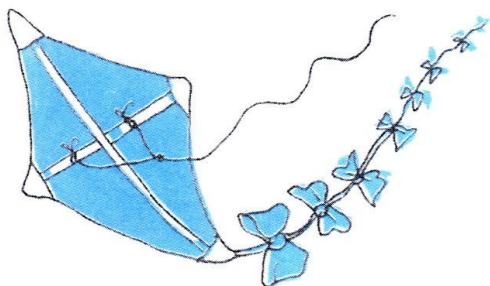
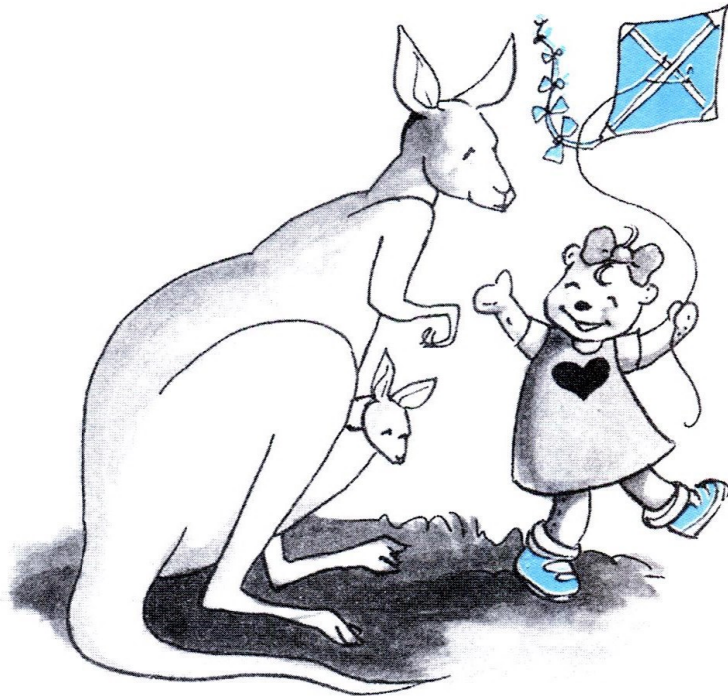

kite

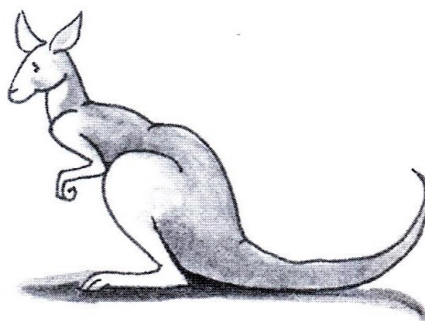

kangaroo

2

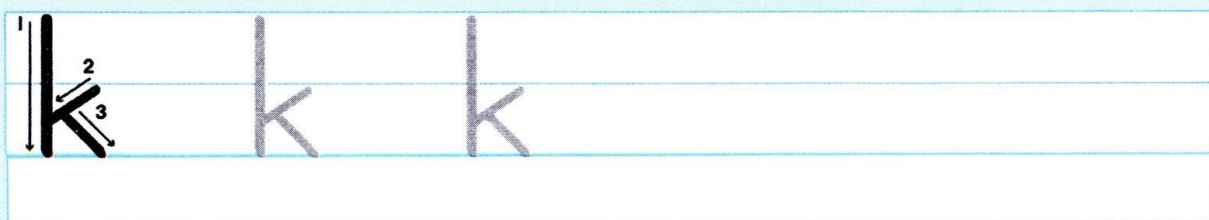
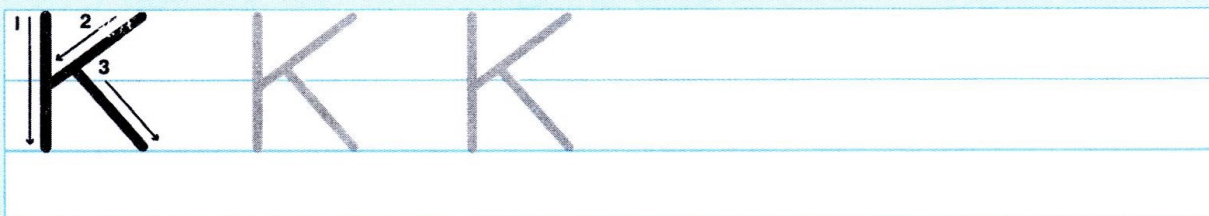

3  Find the kite.

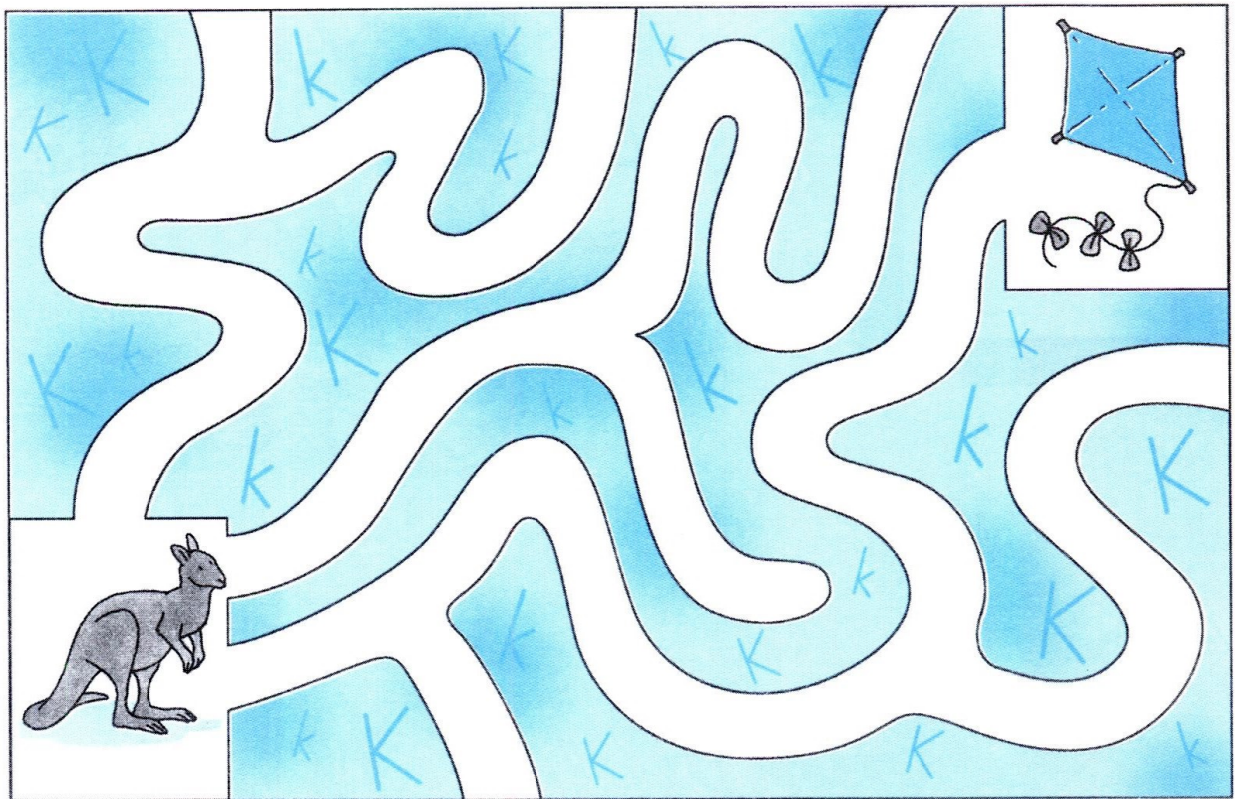

4   

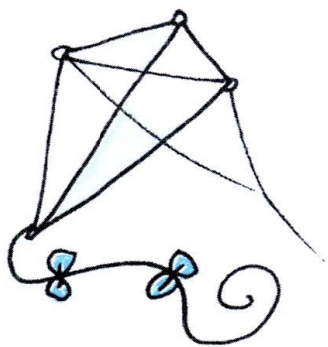

5    



1

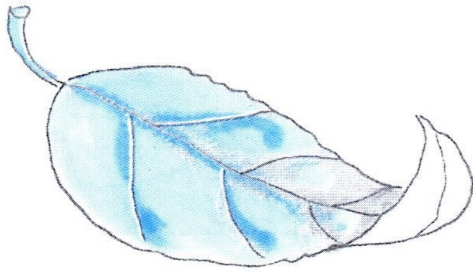
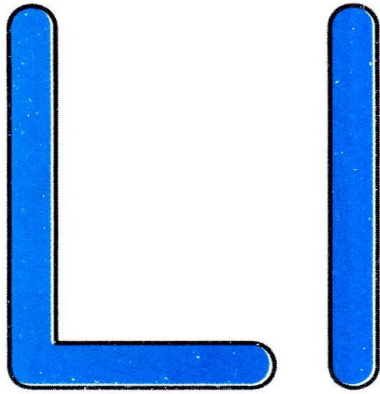

leaf

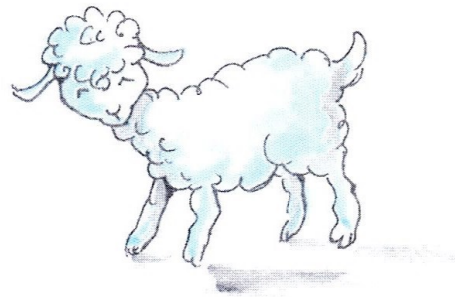

lamb

2 

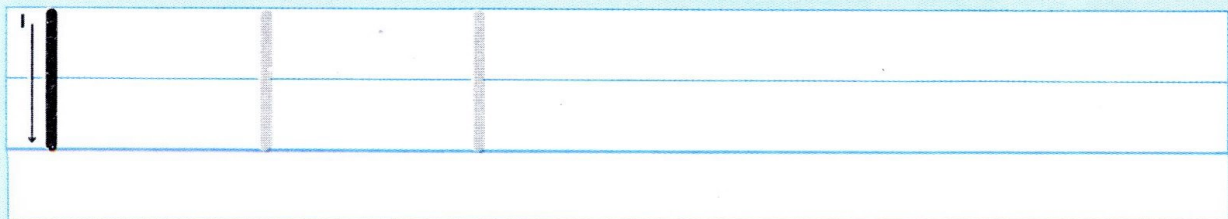
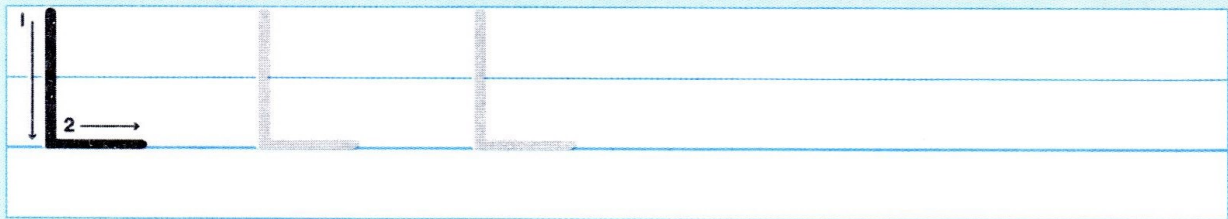

3



Match.

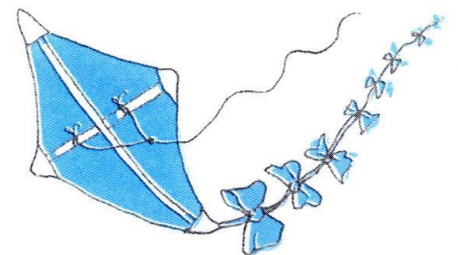
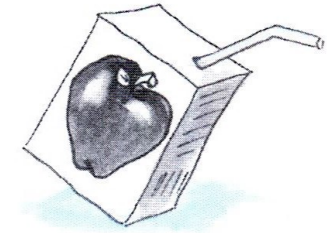
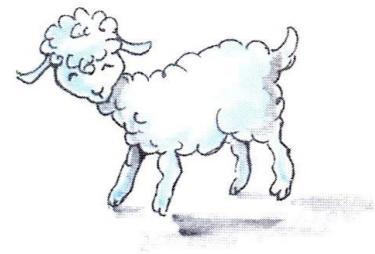
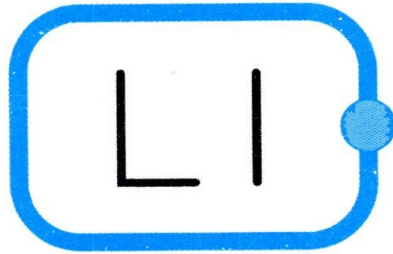
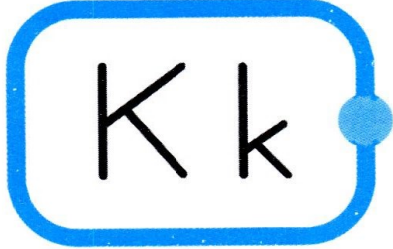
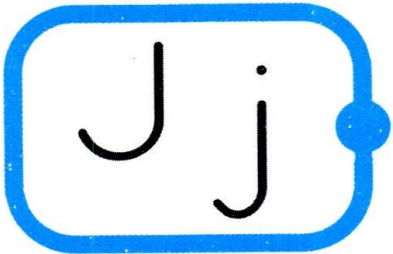

4

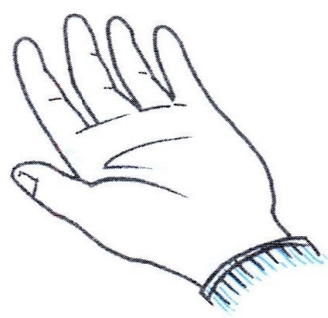
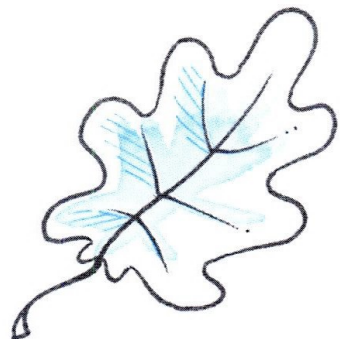

5



L



L



L

L

L





Mm

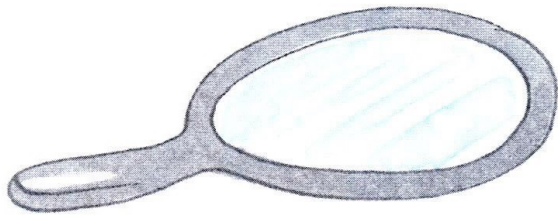

mirror



monster

2 M 

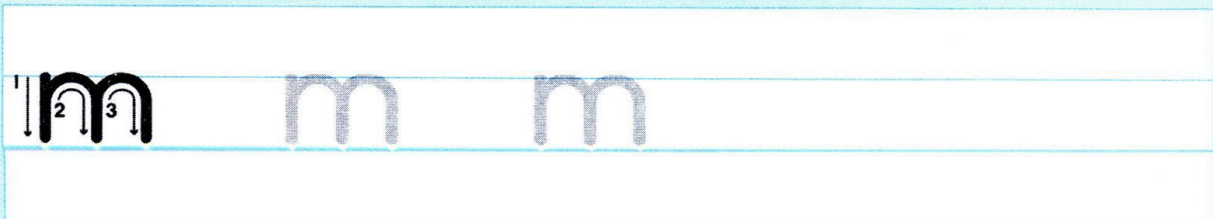
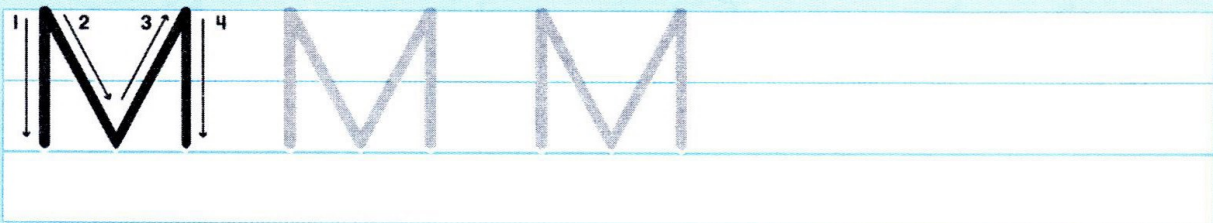

3



Find and circle the letters.

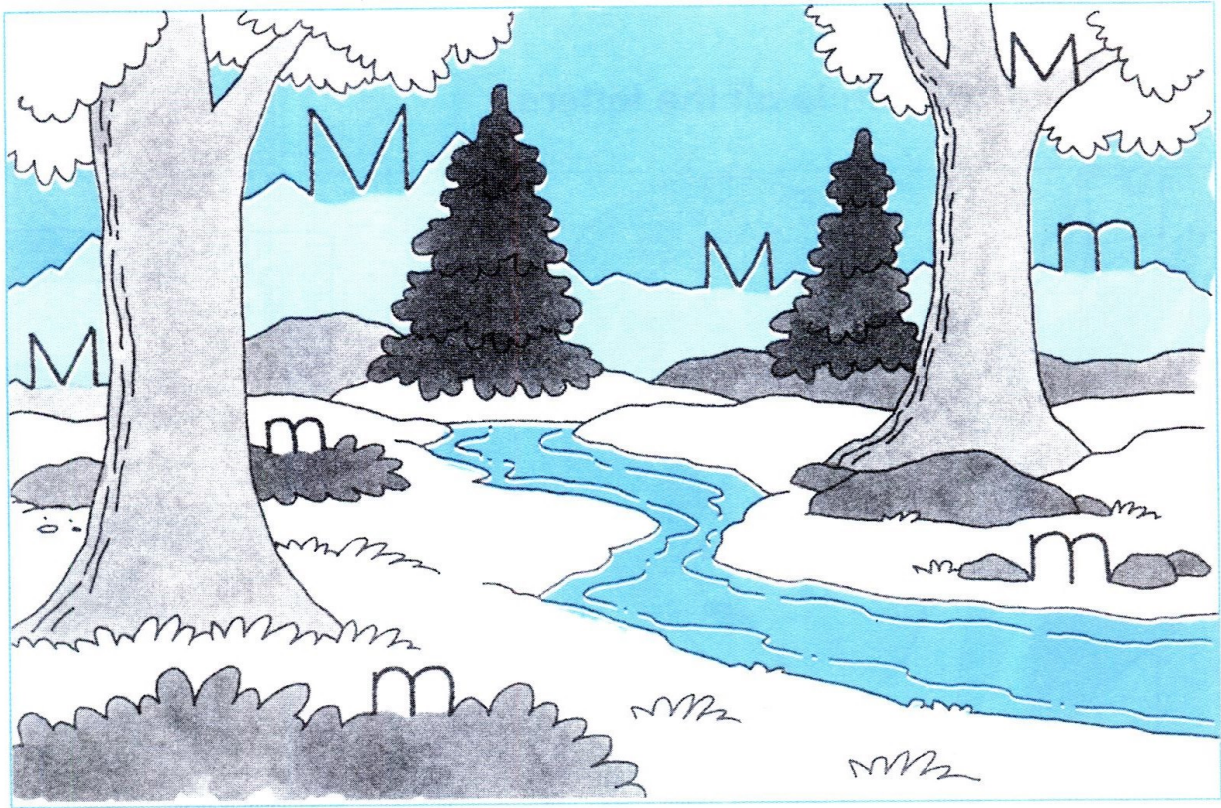

4

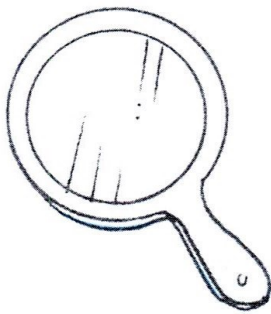

5



M



M



M

M

M





Find and circle all the letters.

www.irLanguage.com

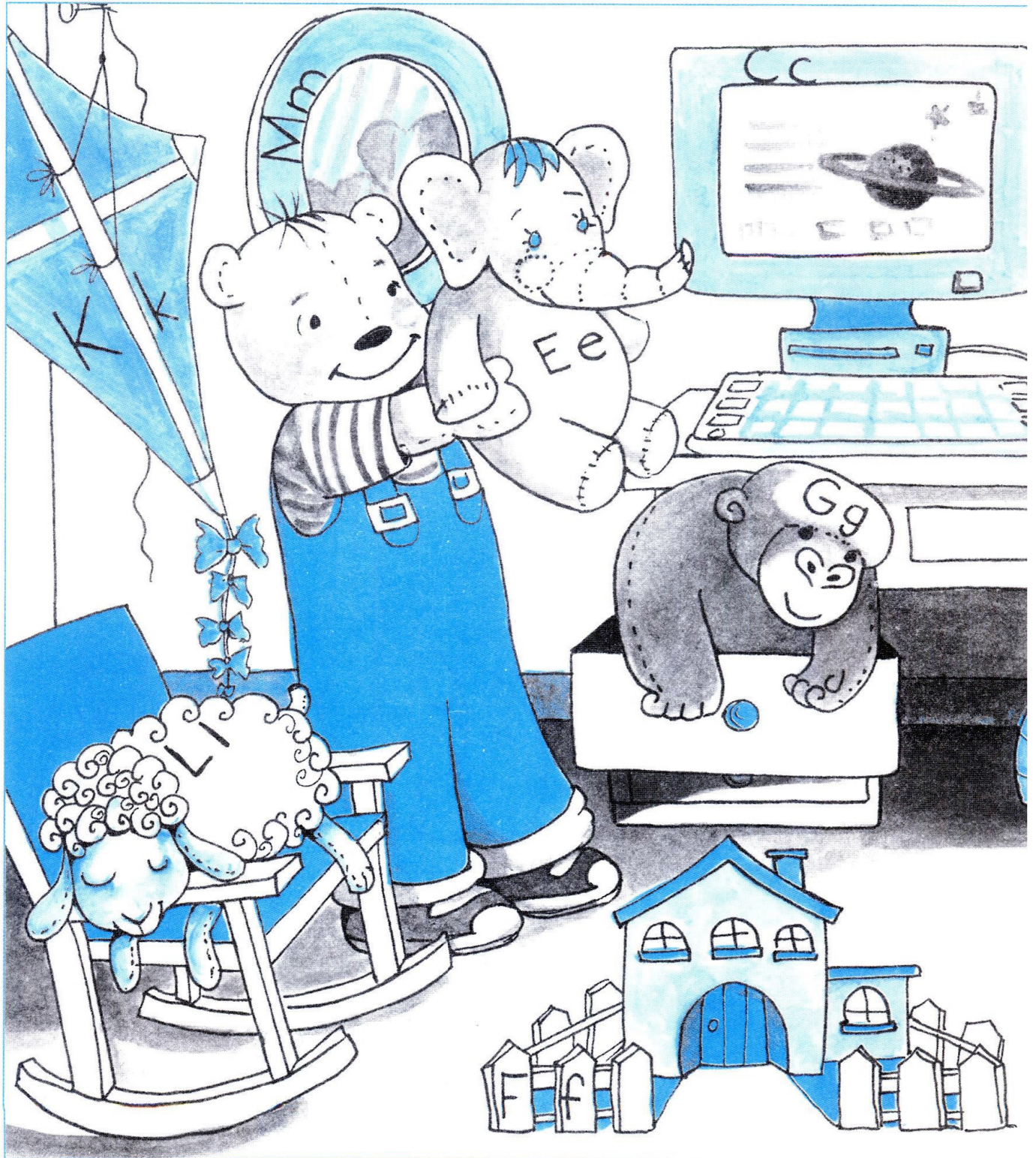

Ff Gg Hh Ii Jj Kk Ll Mm





Nn

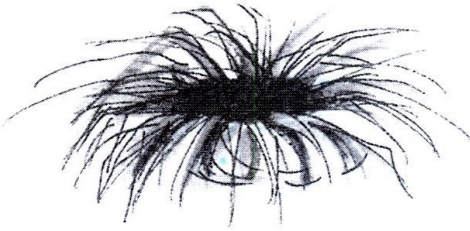
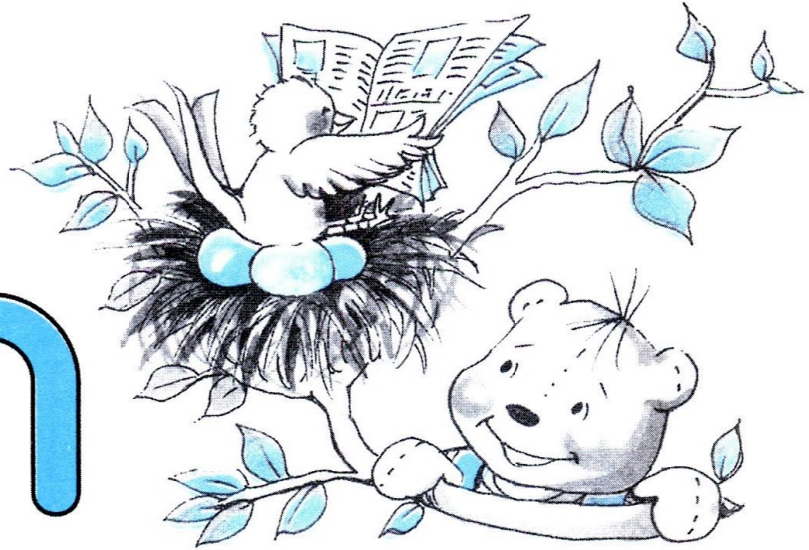

nest

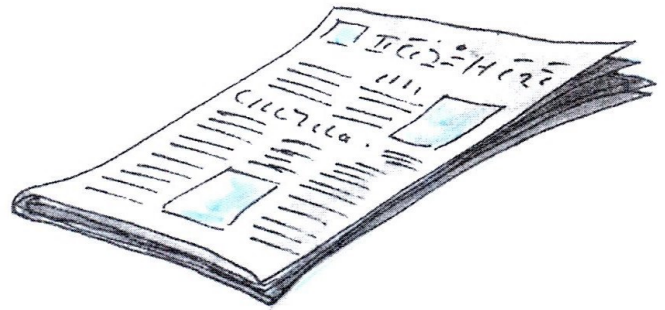

newspaper

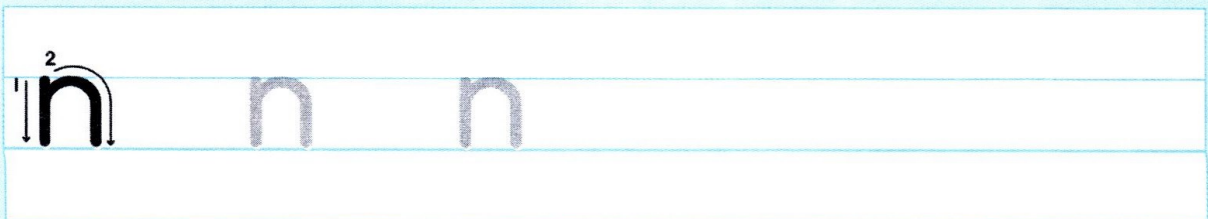
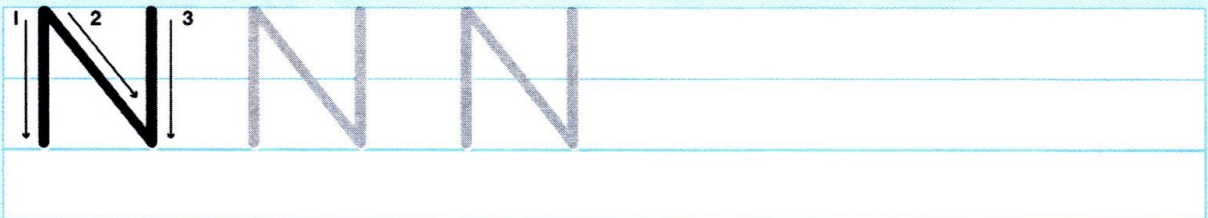

3  Circle the "N" and "n" letters.

N N N H L J
M E N K N

n m n h n
n c n f

4   

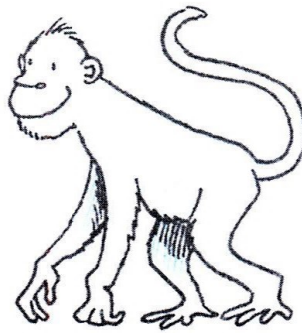
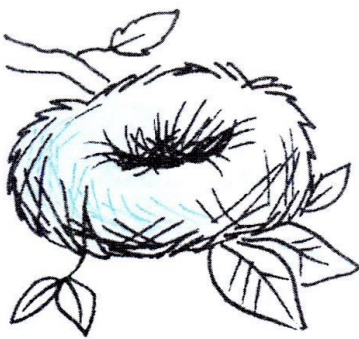

5    

N  **N**  **N N N** 

1

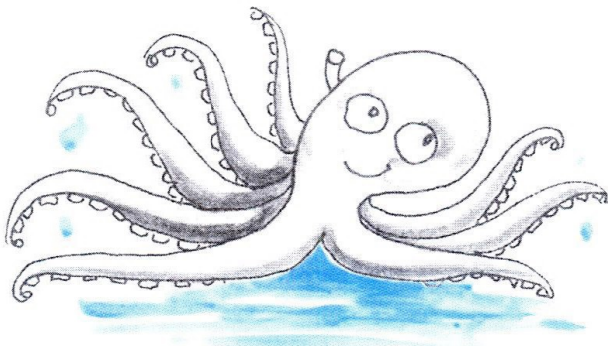
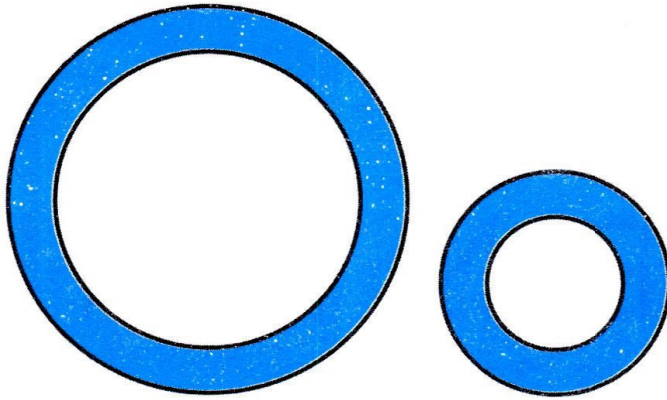

octopus

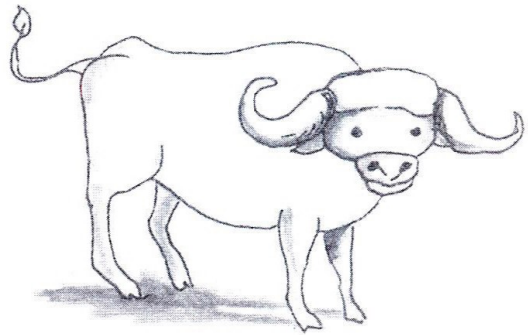

ox

2



www.irLanguage.com

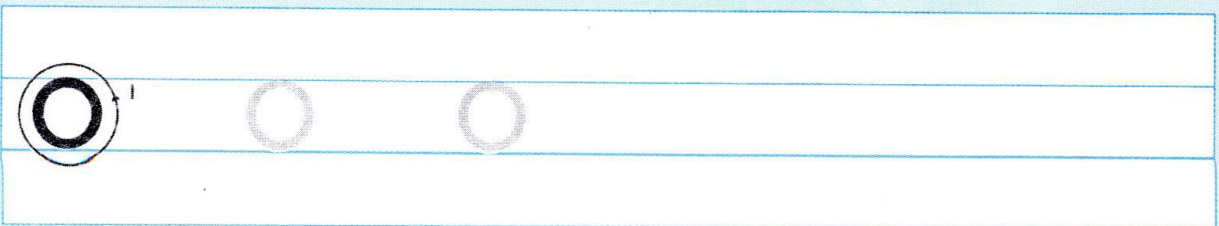
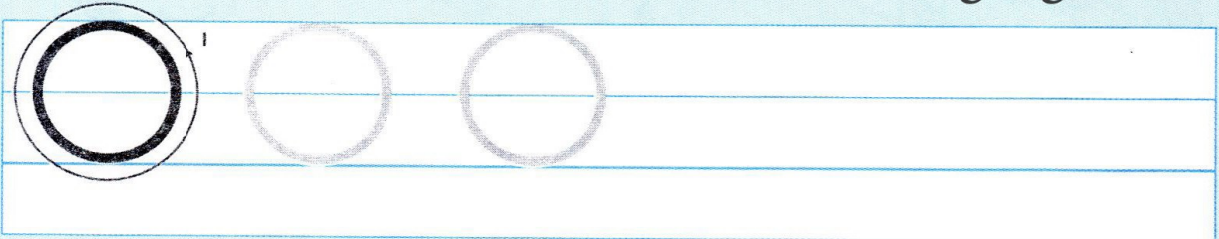

3

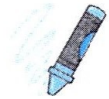

Color the "o" words.

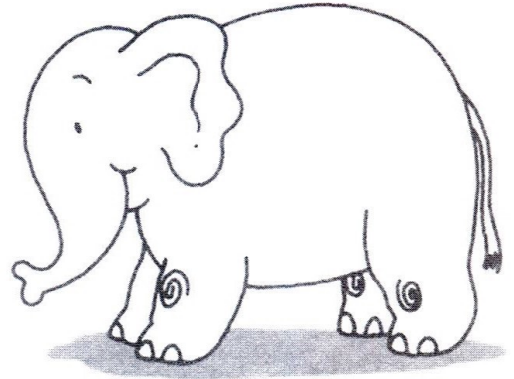
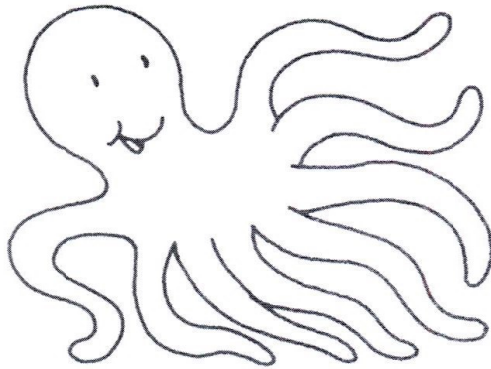
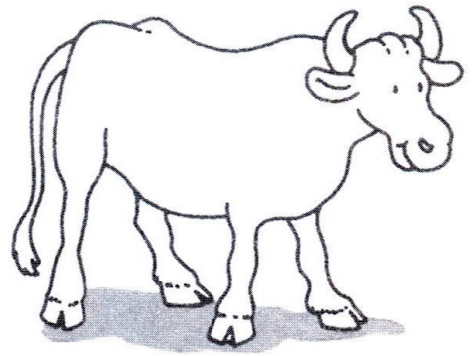
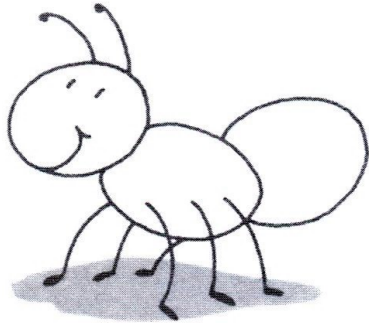

4

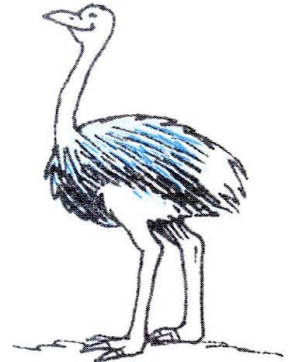
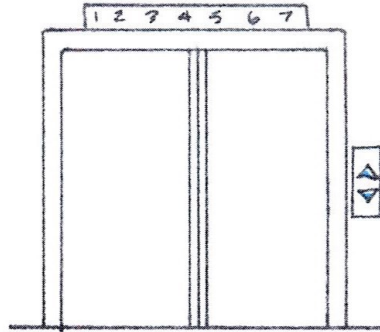
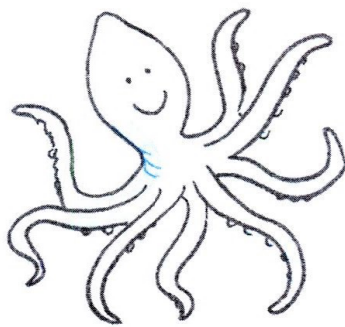

5



o



o



o

o

o



1



P p

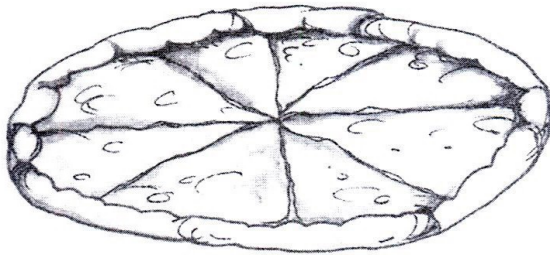

pizza



pirate

2

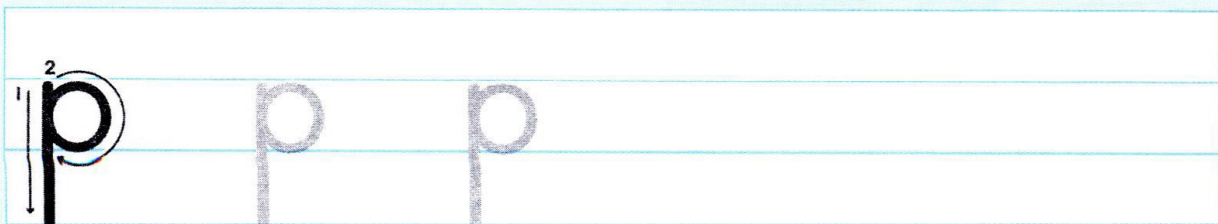
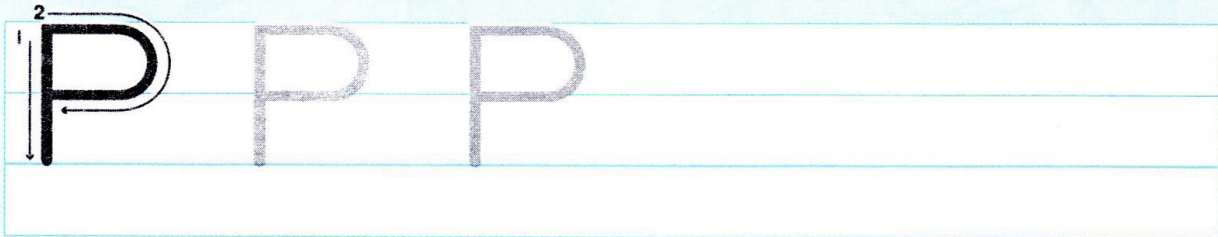

3  Find and circle the letters.

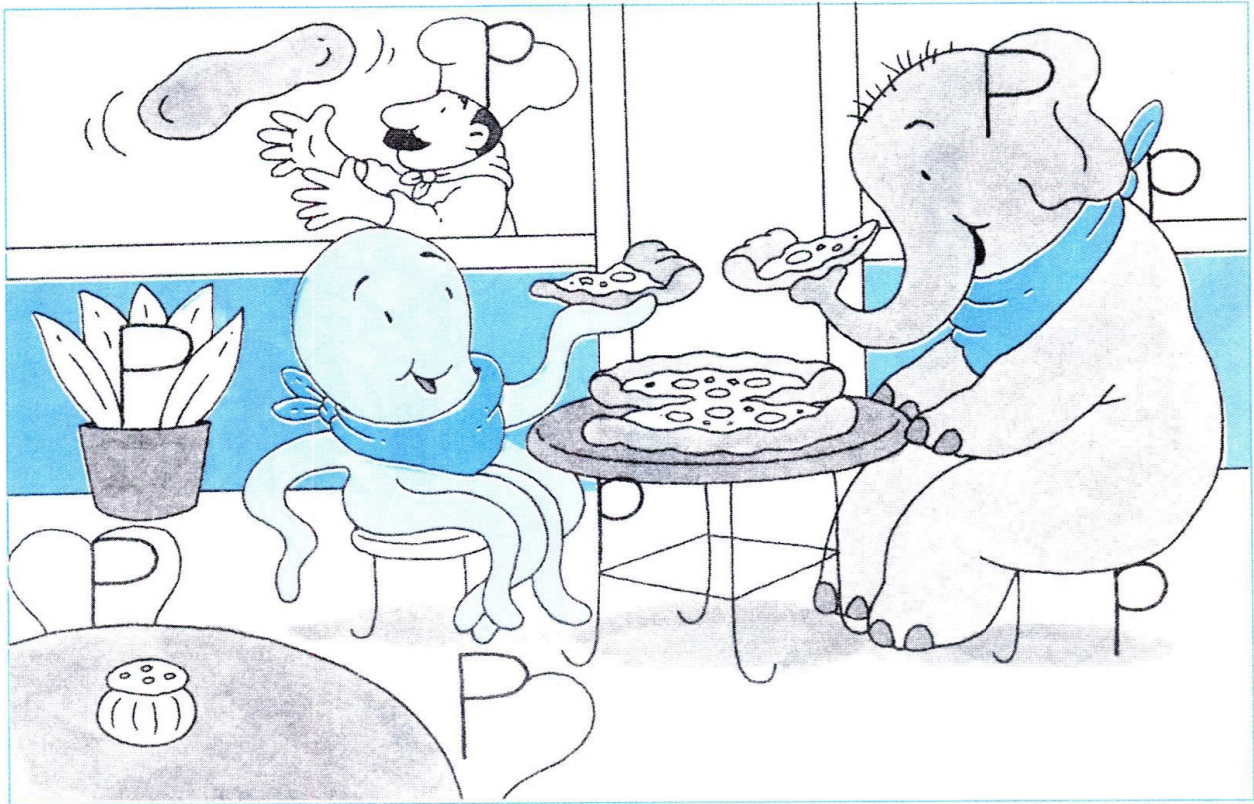

4   

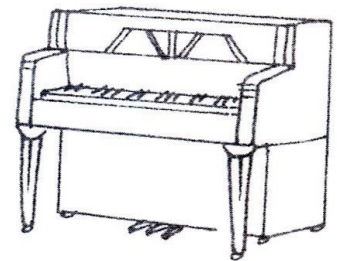
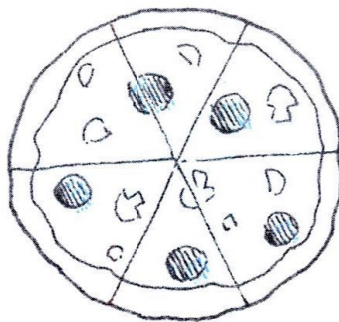
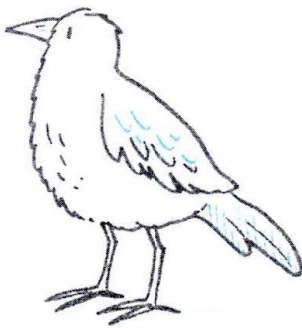

5    

P



P



P

P

P



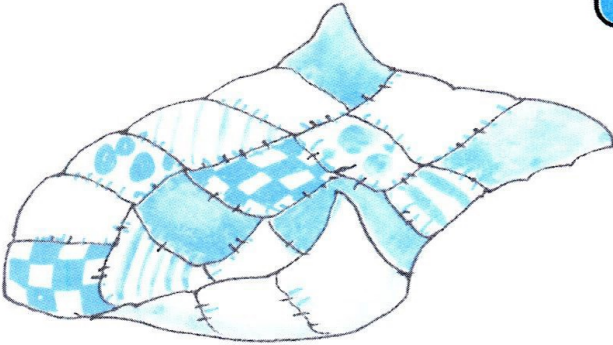
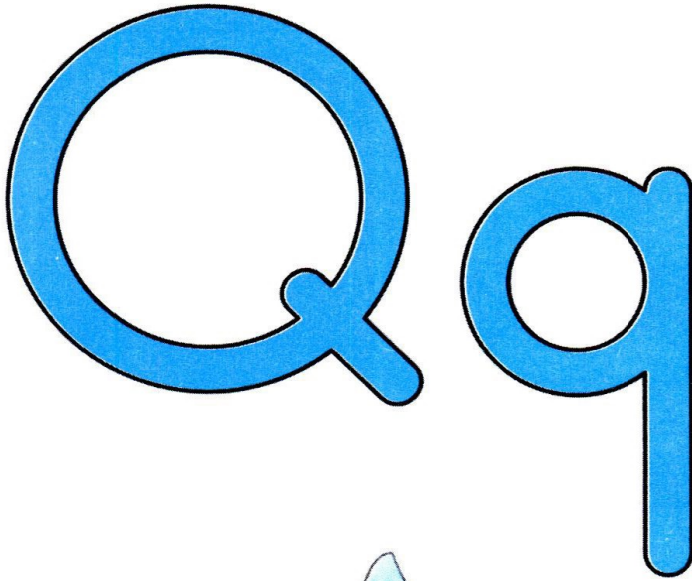

quilt



queen

2



www.irLanguage.com

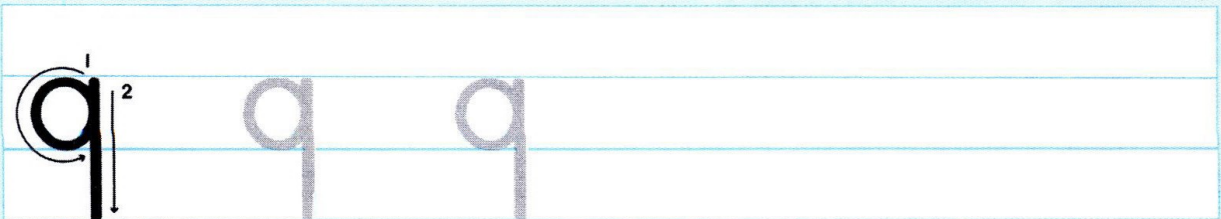
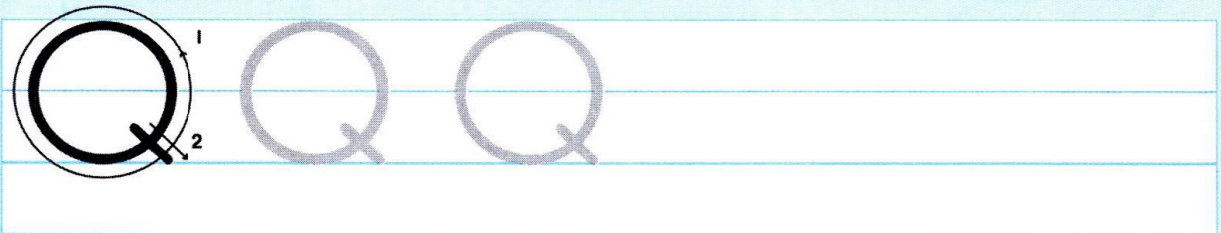

3



Find the quilt.

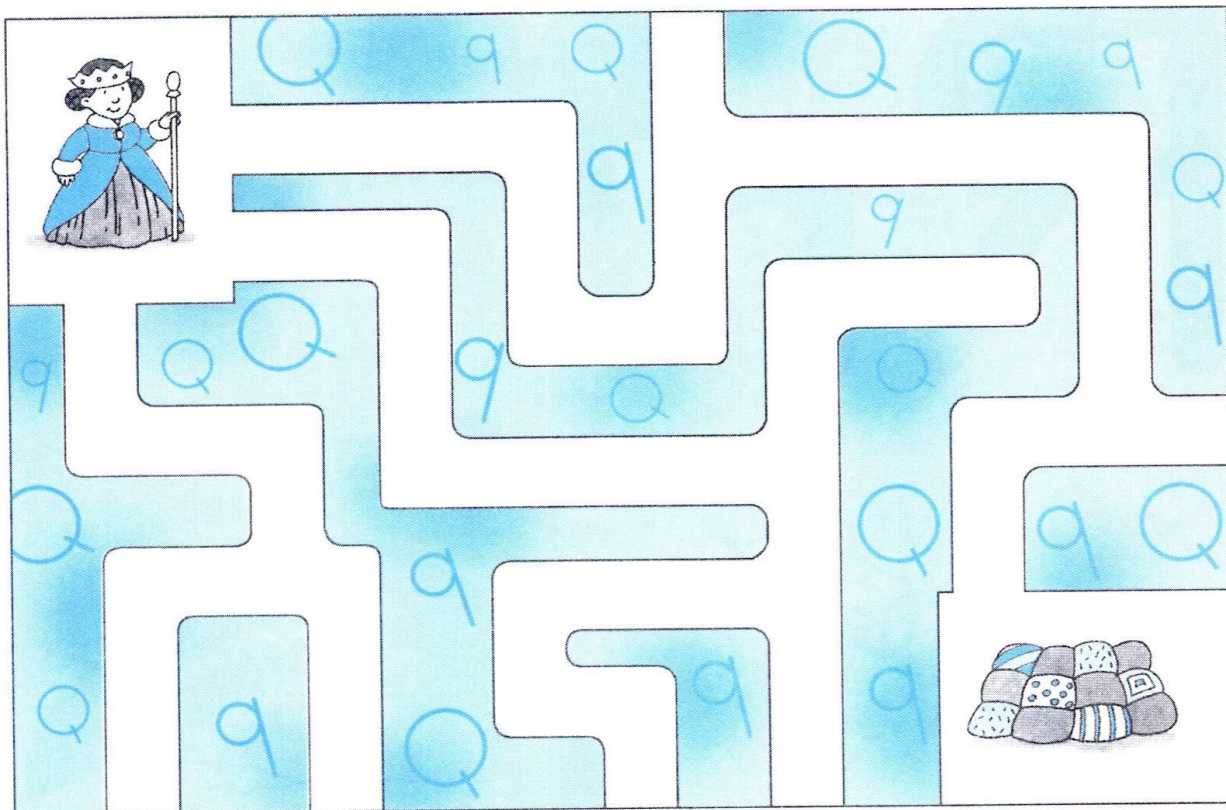

4

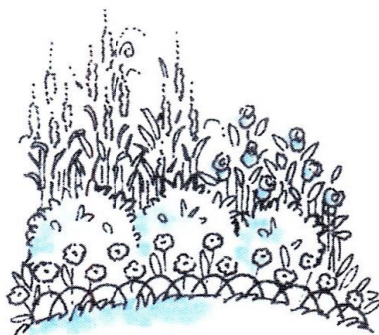
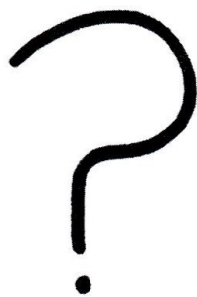

5



Q



Q



Q

Q

Q





Rr

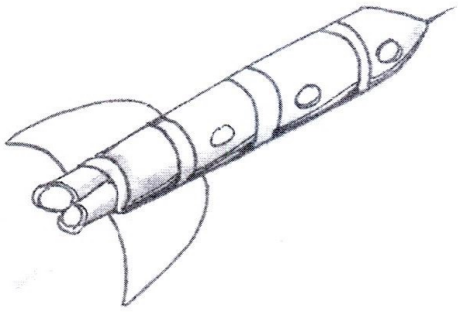
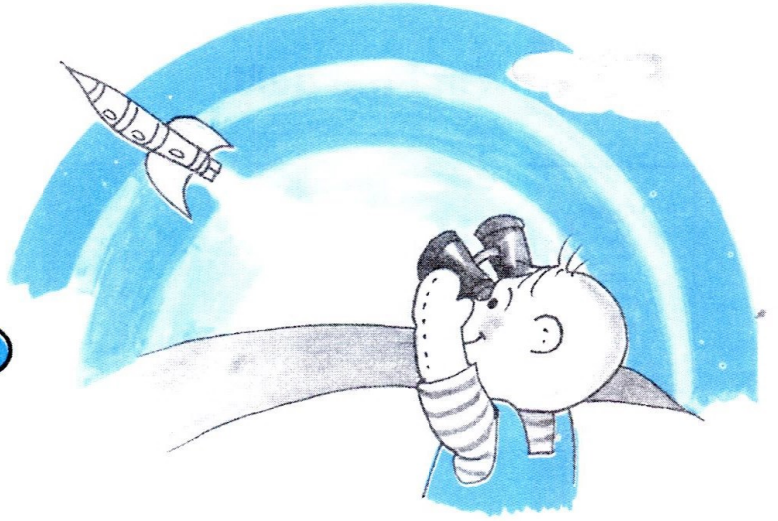

rocket

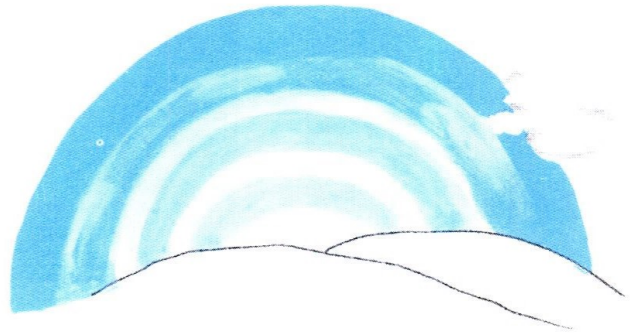

rainbow

2 R 



3



Match.

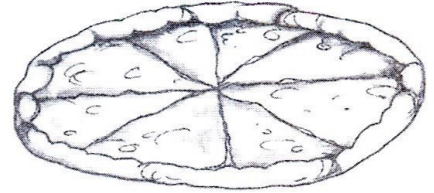
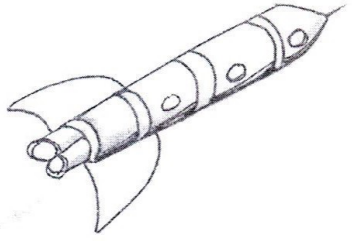
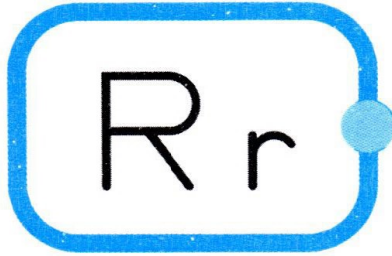
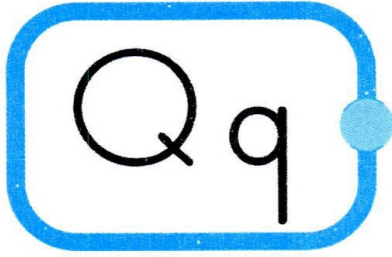
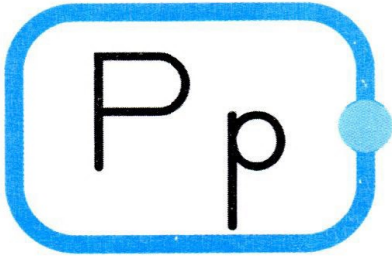

4

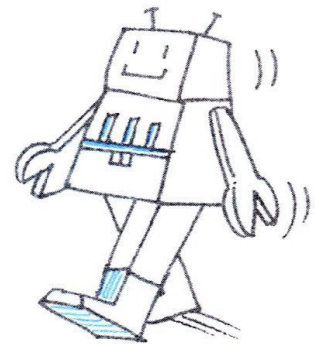

5



R



R



R

R

R



1



S s

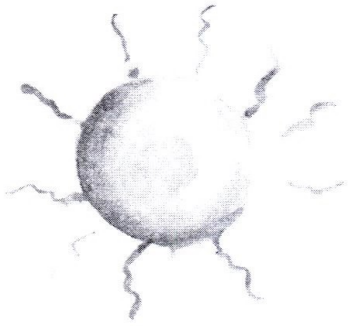
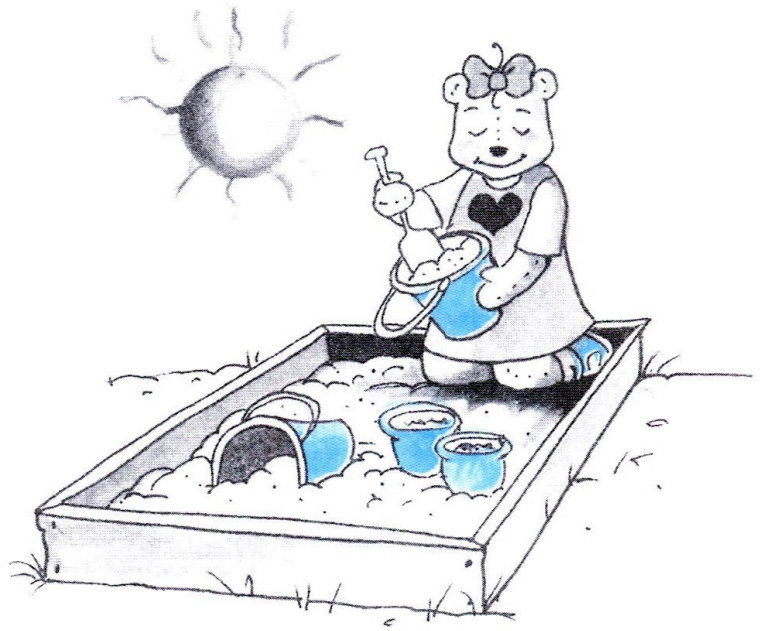

sun

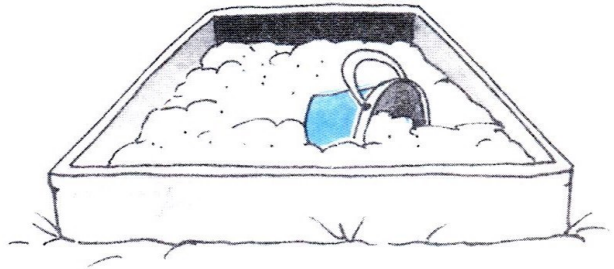

sandbox

2



S S S

s s s

3



Color the "s" words.

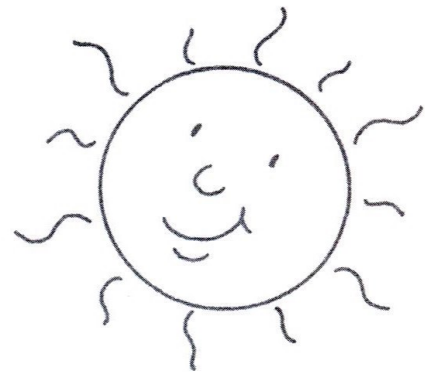
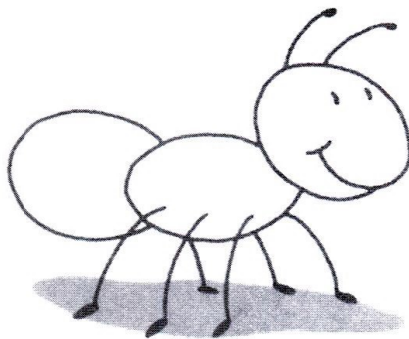
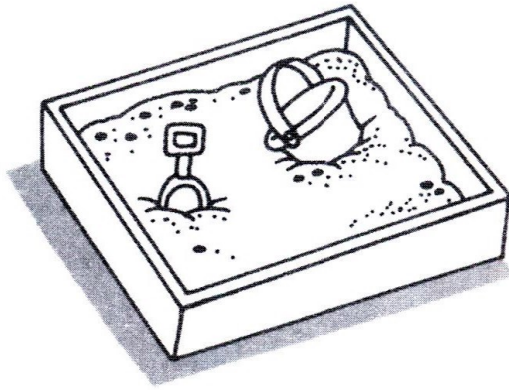
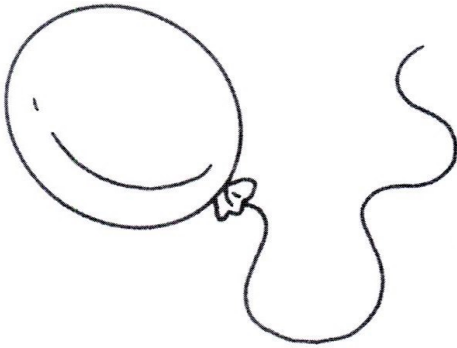

4

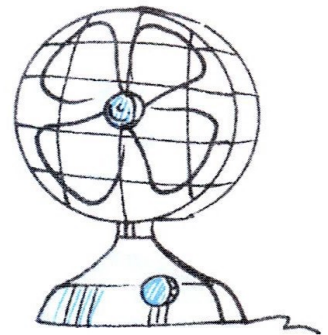
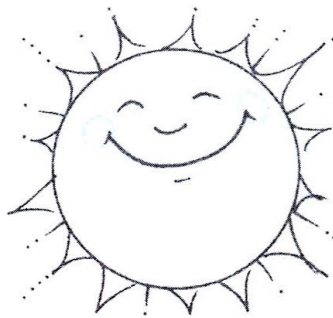
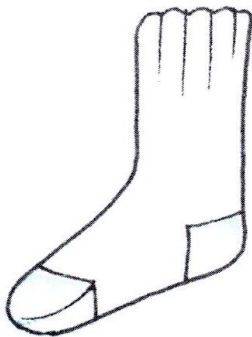

5



S



S



S

S

S





T t

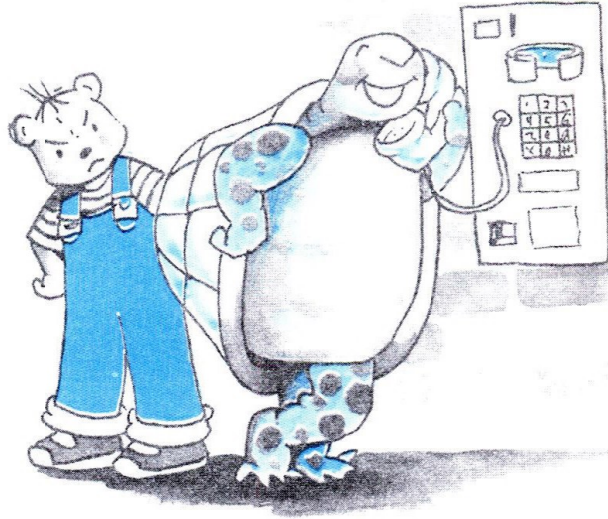

مرجع آموزش زبان ایرانیان
www.OL.com
irLanguage.com

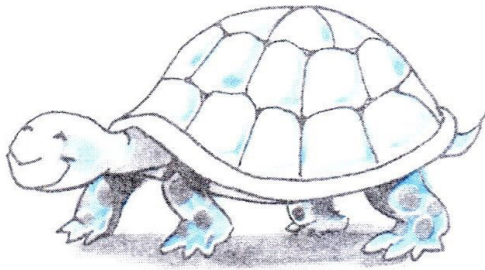

turtle

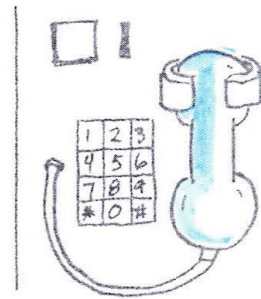

telephone

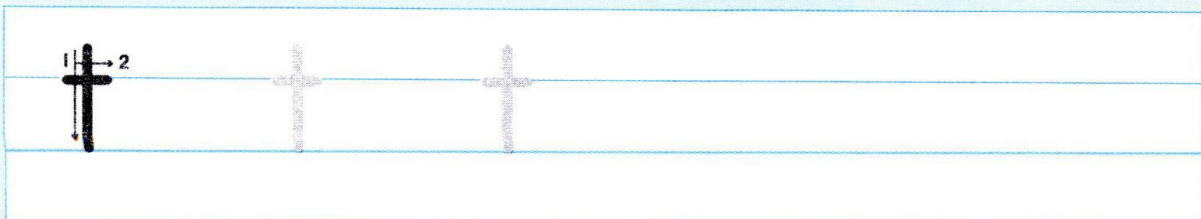
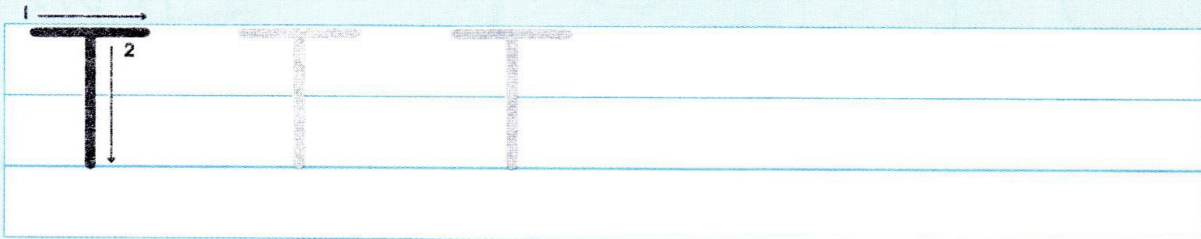

3



Circle the "T" and "t" letters.

T

F T E T

T H T L

t l t h

f t k t

4

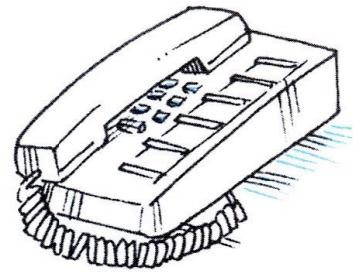
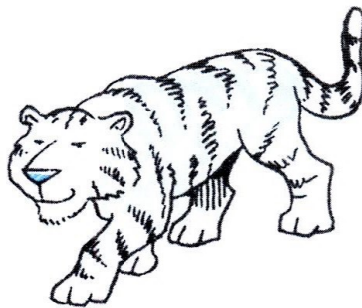

5



T



T



T

T

T





U u



umbrella

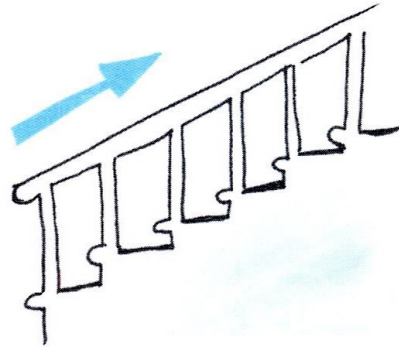

upstairs

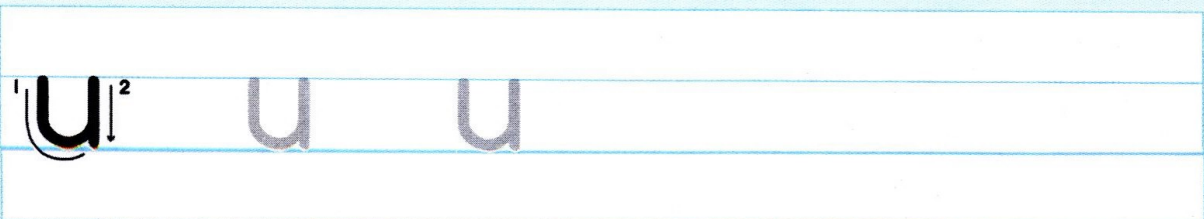
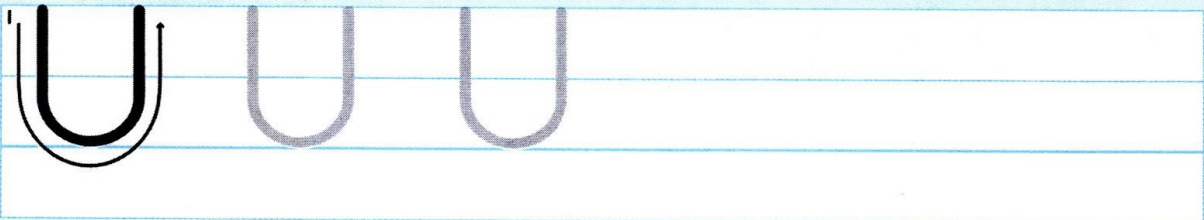

3  Find and circle the letters.



4   

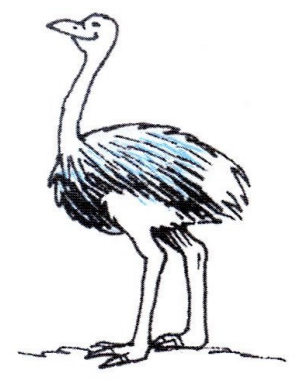

5    

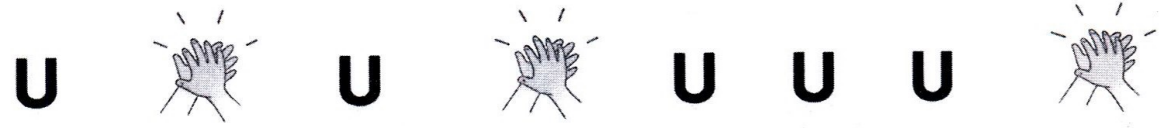



V v

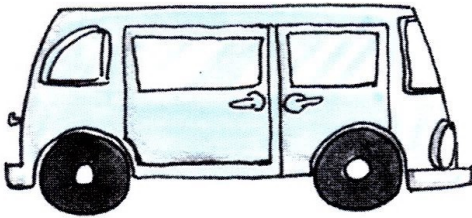
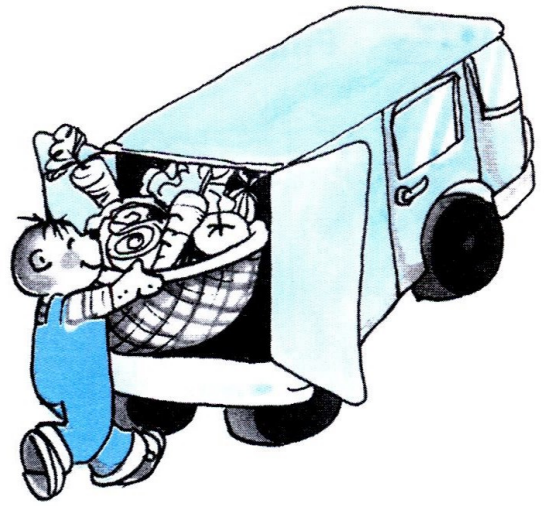

van



vegetables

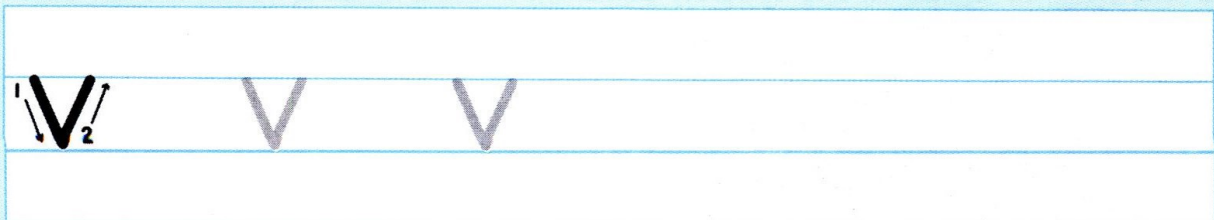

3  Find the van.

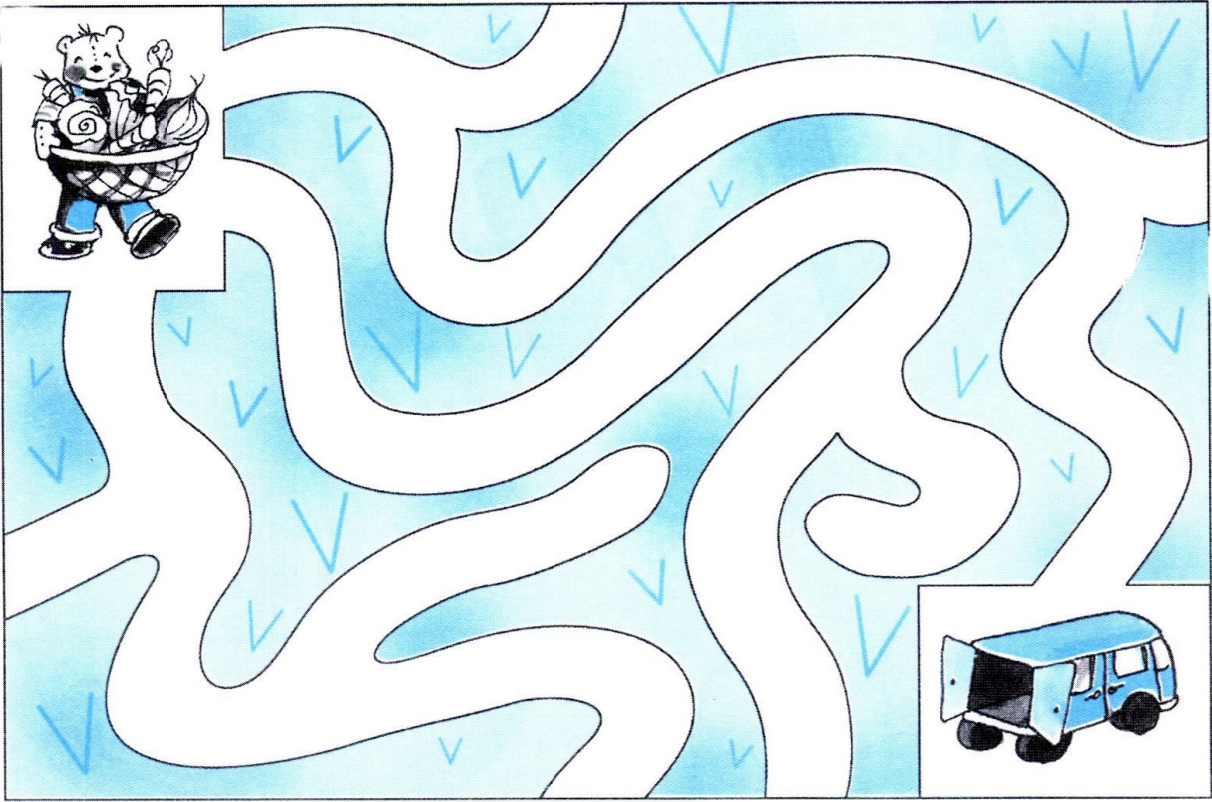

4   

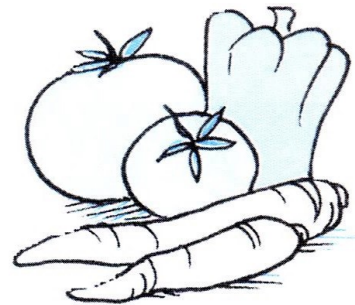

5    





W w

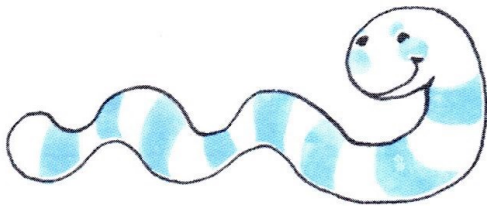

worm

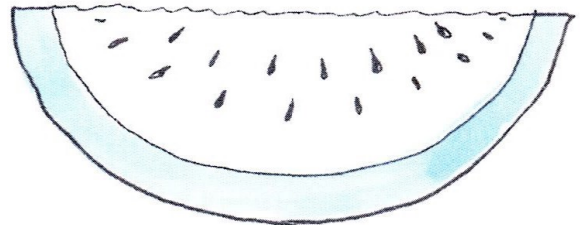

watermelon

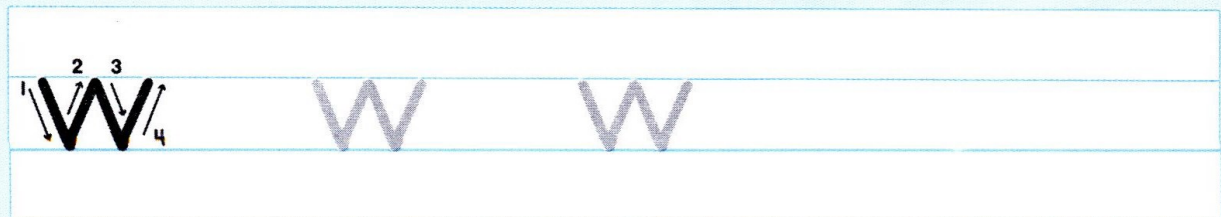
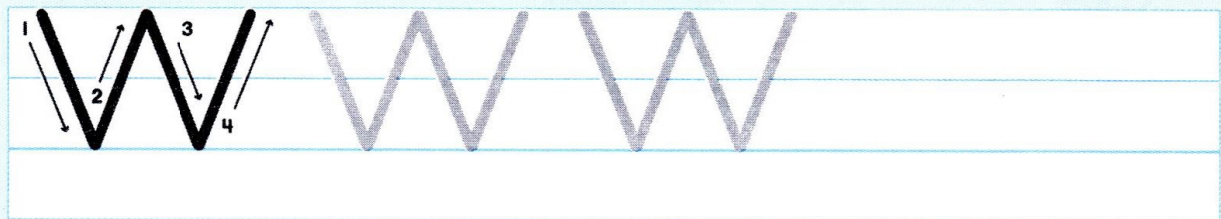

3



Match.

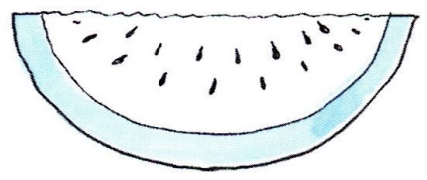
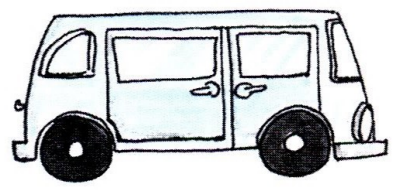
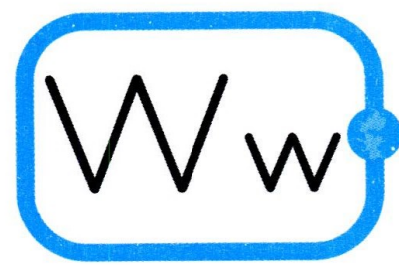
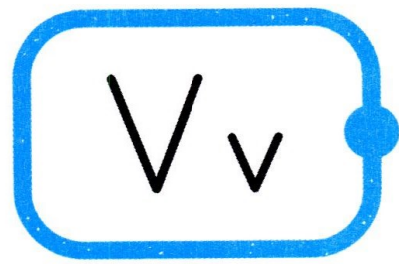
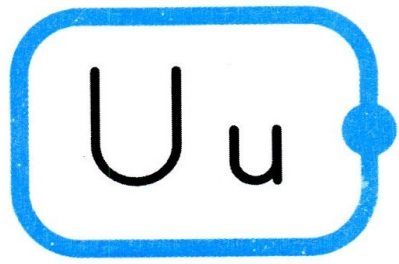

4

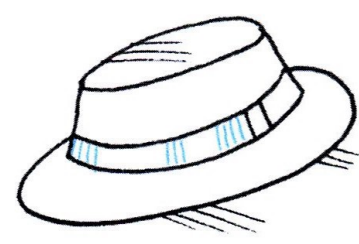
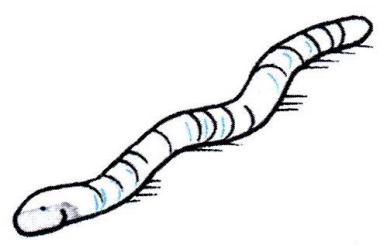

5

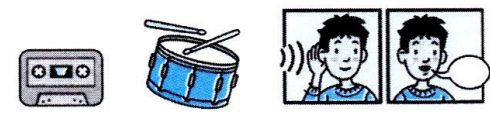

W



W



W

W

W





X x



fox



six



Tracing practice for uppercase 'X'. The first row shows a black 'X' with stroke order arrows (1 and 2) and two grey 'X's for tracing. Below is a blank line for independent practice.

Tracing practice for lowercase 'x'. The first row shows a black 'x' with stroke order arrows (1 and 2) and two grey 'x's for tracing. Below is a blank line for independent practice.

3  Circle the "X" and "x" letters.

 E T H X
X F X X

 x v k x
w x x r

4    Listen and circle the words with "x."

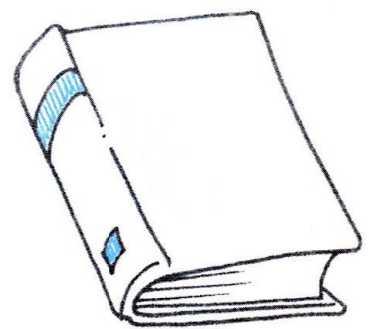
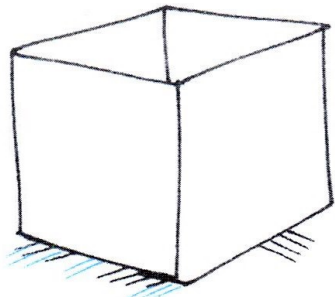

5    

X  X  X X X 

1

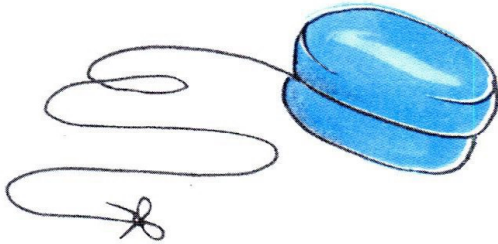
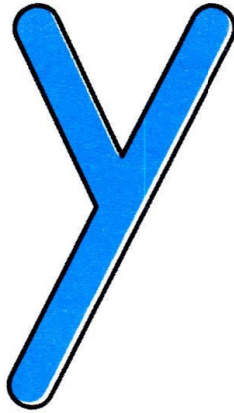
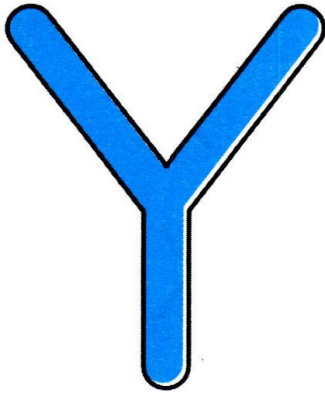

yo-yo

yogurt

2



www.irLanguage.com

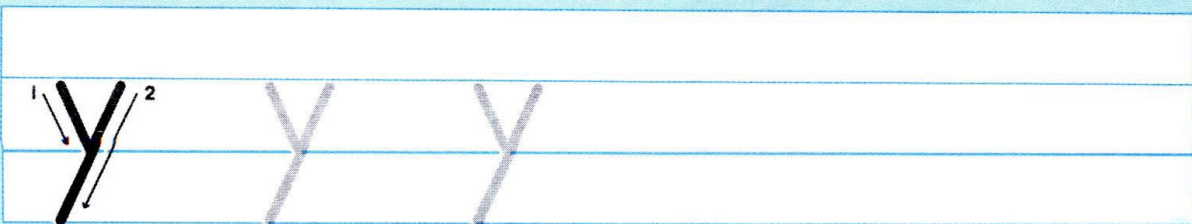
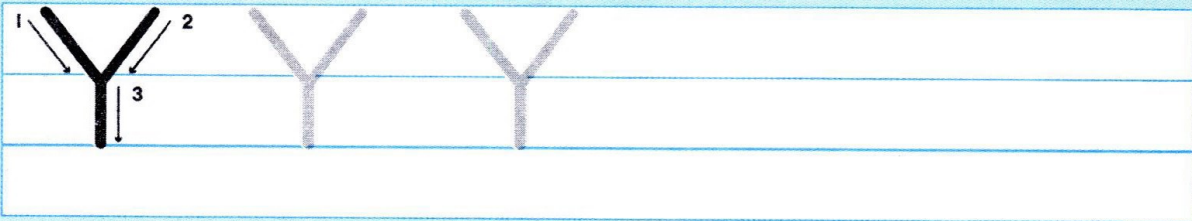

3



Color the "y" words.

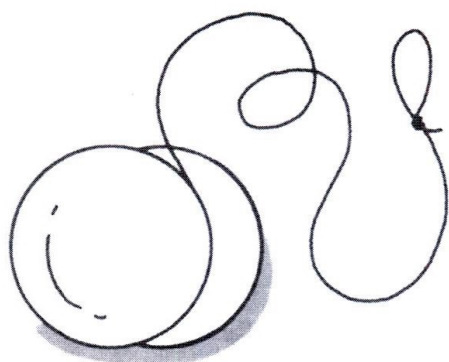
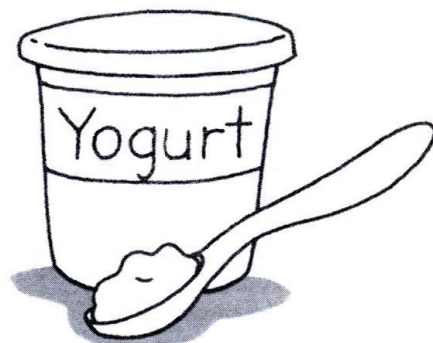
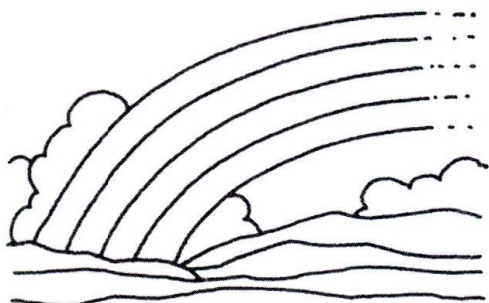

4

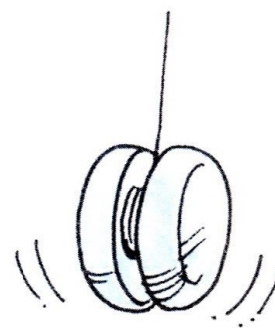
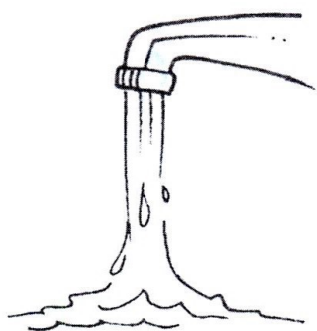

5



Y



Y



Y

Y

Y



1



Zz

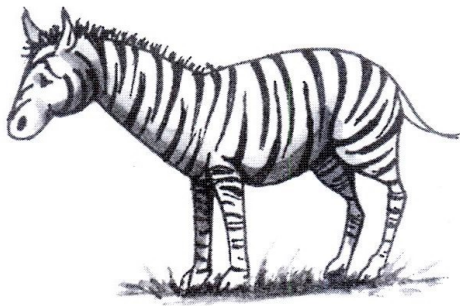
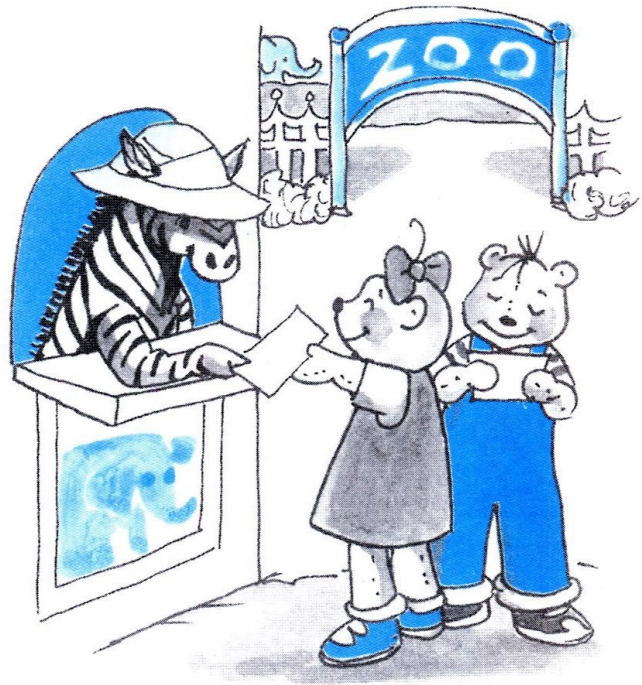

zebra

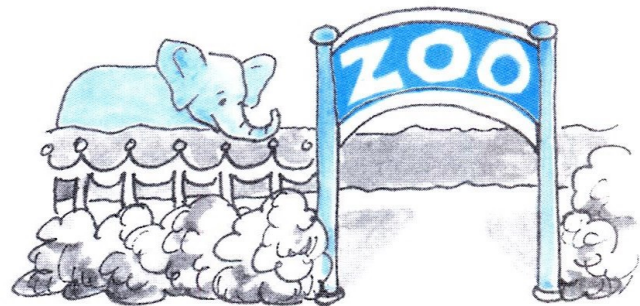

zoo

2

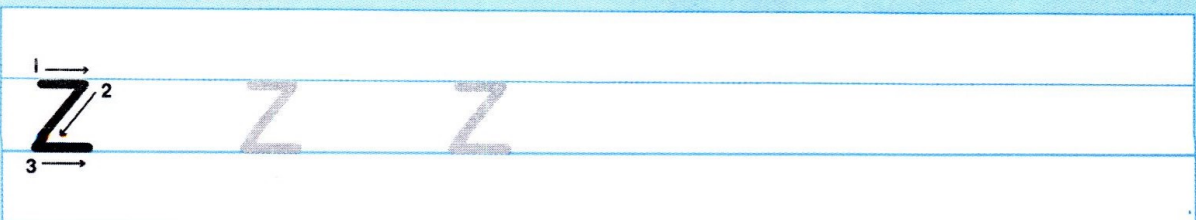
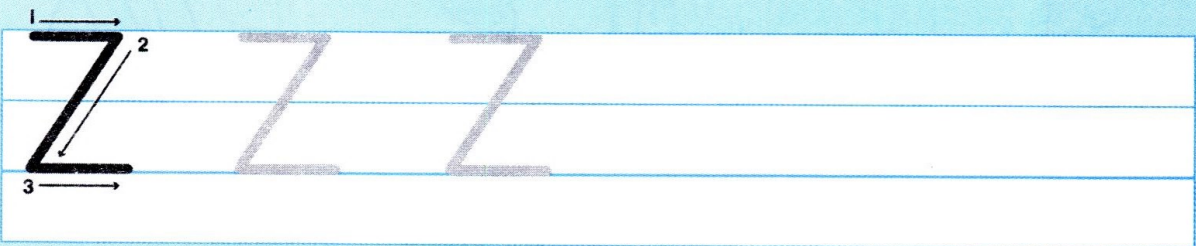

3



Find the zebra.

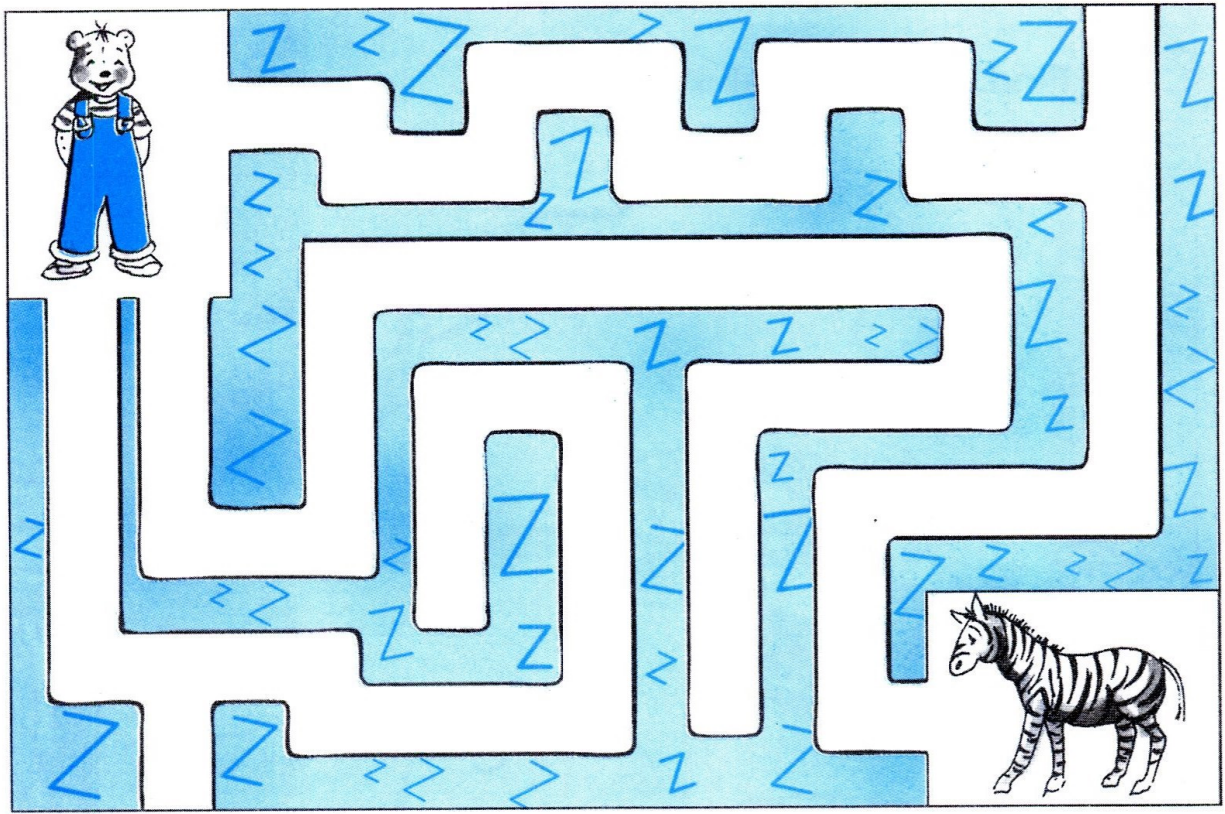

4

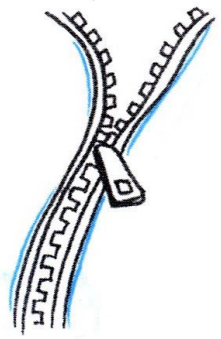
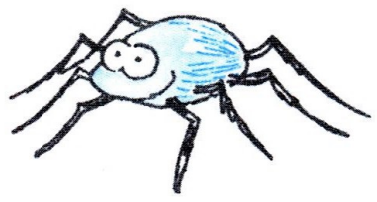
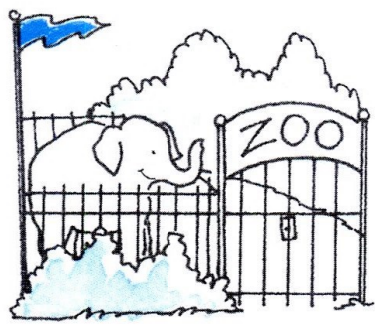

5



Review Unit 2

Nn

Oo

Pp

Qq

Rr



Find and circle all the letters.



Ss Tt Uu Vv Ww Xx Yy Zz



Aa



apple

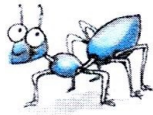

ant

Bb



baby



balloon

Cc



cat



computer

Dd

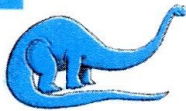

dinosaur



donut

Ee



egg

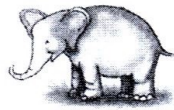

elephant

Ff



fence



farmer

Gg



gorilla

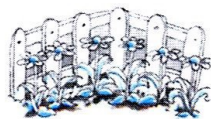

garden

Hh



house

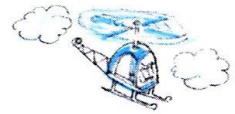

helicopter

Ii



igloo



insect

Jj



jeep



juice

Kk



kite



kangaroo

Ll



leaf



lamb

Mm



mirror



monster

N n

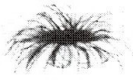

nest

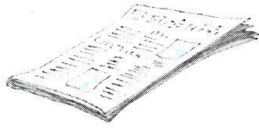

newspaper

O o

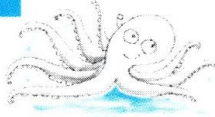

octopus



ox

P p

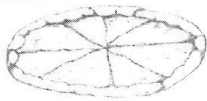

pizza



pirate

Q q



quilt



queen

R r



rocket



rainbow

S s



sun

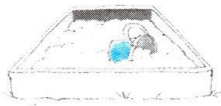

sandbox

T t

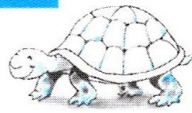

turtle



telephone

U u



umbrella

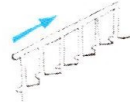

upstairs

V v



van



vegetables

W w



worm



watermelon

X x



fox



six

Y y

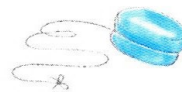

yo-yo



yogurt

Z z



zebra

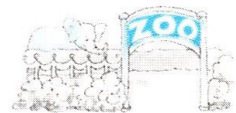

zoo

Tiny Talk

The *Tiny Talk ABC Workbook* introduces preschool students to the letters of the alphabet and their basic sounds. The *Workbook* provides simple practice exercises for reading and writing all 26 letters in a fun and meaningful format. The *Workbook Cassette* offers listening comprehension activities for introducing basic phonics.

The complete *Tiny Talk* course is a three-level series designed for preschool and kindergarten children. The three levels are divided into A and B sections. Each section includes a **Student Book**, a **Workbook**, a **Cassette**, **Picture Cards**, and **Wall Charts**. The easy-to-use **Teacher's Book** provides step-by-step lesson plans and a wide variety of games and fun activities. **Puppets** of the main characters attract and hold children's attention throughout the course.

Also available is the *Tiny Talk Songbook*, which features all 60 songs in the series. Both the *ABC Workbook* and the *Songbook* can be used either independently or as supplements to the *Tiny Talk* course.

Tiny Talk ABC Workbook 0-19-435392-3
Tiny Talk ABC Workbook Cassette (American English) 0-19-436088-1
Tiny Talk ABC Workbook Cassette (British English) 0-19-436752-5

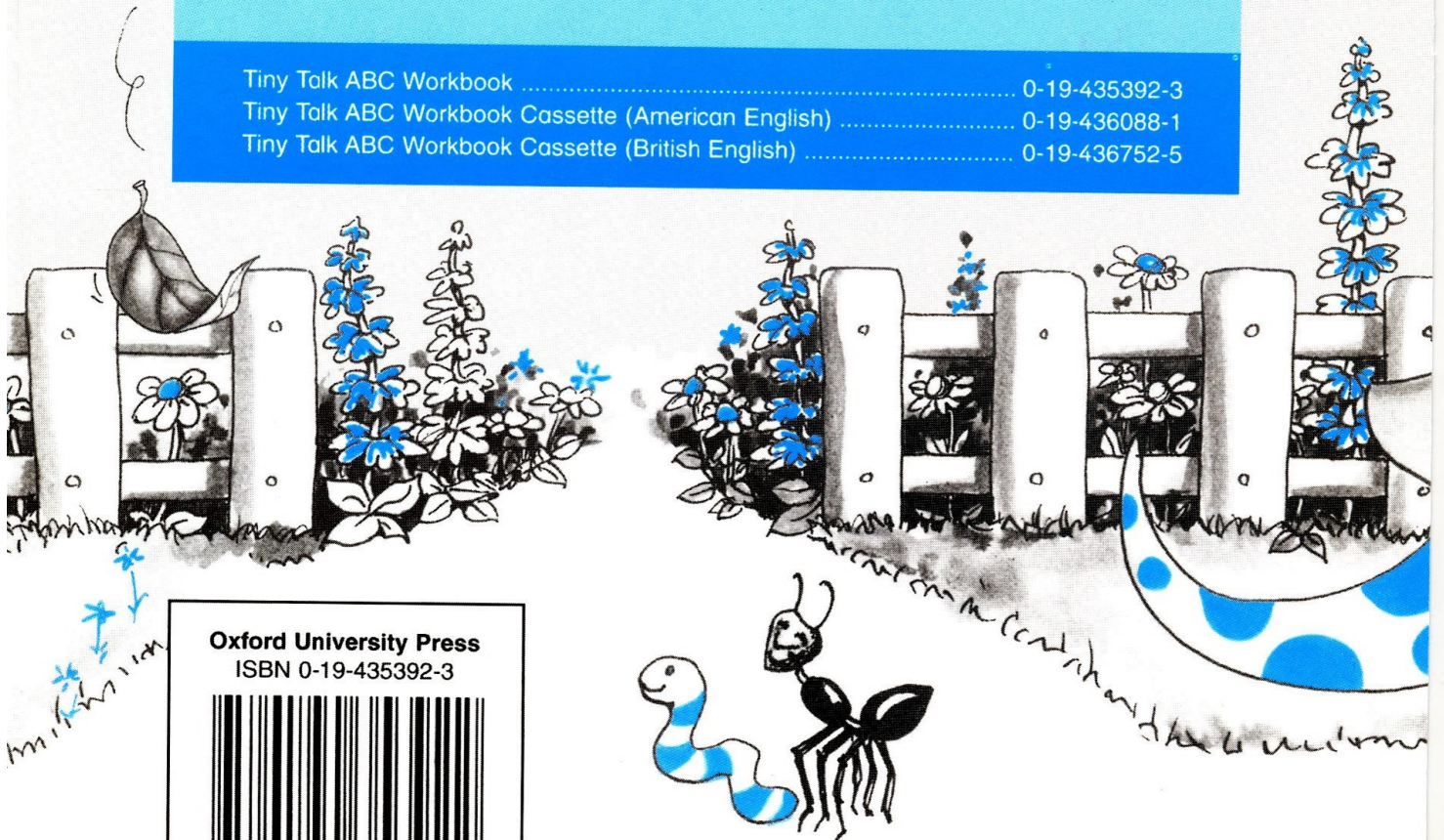

Oxford University Press
ISBN 0-19-435392-3



9 780194 353922